

For product information and support, visit
www.philips.com/dictation

SPEECHMIKE AIR

LFH3000



EN	User manual	3
DE	Benutzerhandbuch	23
FR	Manuel de l'utilisateur	43
ES	Manual del usuario	63

IT	Manuale di istruzioni	83
NL	Gebruikershandleiding	103
SV	Användarhandbok	123

PHILIPS

User manual

1	Important	4	4	Use your SpeechMike Air	15
			4.1	Create a recording	15
2	Your SpeechMike Air	7	5	Use more of your SpeechMike Air	16
2.1	What's in the box	7	5.1	Customize the SpeechMike	16
2.2	Overview SpeechMike Air	8	5.1.1	Customize SpeechMike keys and settings	16
2.2.1	Dictation microphone	8	5.1.2	Use application shortcuts	17
2.2.2	Docking station	9	5.1.3	Update the firmware	18
2.2.3	Receiver module	9	5.2	Record with a headset or an external microphone	19
3	Get started	10	6	Technical data	20
3.1	Install the software	10	7	Frequently asked questions	21
3.2	Connect the docking station	10			
3.3	Insert the batteries	11			
3.4	Charge the batteries	11			
3.4.1	Charging using the docking station and the AC charger	11			
3.4.2	Charging using the docking station and the USB cable	12			
3.4.3	Charging directly through the SpeechMike	12			
3.5	Learn about the battery charge level	12			
3.6	Turning on/off the SpeechMike	13			
3.7	Set up the wireless connection manually	13			
3.7.1	Set up the wireless connection manually using the docking station	13			
3.7.2	Set up the wireless connection manually using the receiver module	13			
3.8	Learn about wireless connectivity	14			
3.9	Power-save mode	14			
3.10	Locate the SpeechMike	14			
3.11	Attach the neckband	14			

1 Important

Philips reserves the right to change products at any time without being obliged to adjust earlier supplies accordingly.

The material in this manual is believed adequate for the intended use of the system. If the product, or its individual modules or procedures, are used for purposes other than those specified herein, confirmation of their validity and suitability must be obtained.

Safety

- To avoid a short circuit, do not expose the product to rain or water.
- Do not expose the device to excessive heat caused by heating equipment or direct sunlight.
- Protect the cables from being pinched, particularly at plugs and the point where they exit from the unit.
- All wireless devices may be susceptible to interference, which could affect performance.
- Back up your files. Philips is not responsible for any loss of data.

Hearing safety

Observe the following guidelines when using your headphones:

- Listen at reasonable volumes for reasonable periods of time.
- Be careful not to adjust the volume higher as your hearing adapts.
- Do not turn up the volume so high that you can't hear what's around you.
- You should use caution or temporarily discontinue use in potentially hazardous situations.
- Do not use headphones while operating a motorized vehicle, cycling, or skateboarding, etc. It may create a traffic hazard and is illegal in many areas.

Important (for models supplied with headphones):

Philips guarantees compliance with the maximum sound power of its audio players as determined by relevant regulatory bodies, but only with the original model of provided headphones. If these headphones need replacement, we recommend that you contact your retailer to order a Philips model identical to that of the original.

Small children

Your device and its enhancements may contain small parts. Keep them out of the reach of small children.

Operating environment

This device meets RF exposure guidelines when used either in the normal use position against the ear or when positioned at least 2.2 centimetres (7/8 inch) away from the body. When a carry case, belt clip, or holder is used for body-worn operation, it should not contain metal and should position the device the above-stated distance from your body.

Parts of the device are magnetic. Metallic materials may be attracted to the device. Do not place credit cards or other magnetic storage media near the device, because information stored on them may be erased.

Medical devices

Operation of any radio transmitting equipment may interfere with the functionality of inadequately protected medical devices. Consult a physician or the manufacturer of the medical device to determine if they are adequately shielded from external RF energy or if you have any questions. Switch off your device in health care facilities when any regulations posted in these areas instruct you to do so. Hospitals or health care facilities may be using equipment that could be sensitive to external RF energy.

Implanted medical devices

Manufacturers of medical devices recommend that a minimum separation of 15.3 centimetres (6 inches) should be maintained between a wireless device and an implanted medical device, such as a pacemaker or implanted cardioverter defibrillator, to avoid potential interference with the medical device. Persons who have such devices should:

- Always keep the wireless device more than 15.3 centimetres (6 inches) from the medical device when the wireless device is turned on.
- Not carry the wireless device in a breast pocket.
- Turn the wireless device off immediately if there is any reason to suspect that interference is taking place.
- Read and follow the directions from the manufacturer of their implanted medical device.

If you have any questions about using your wireless device with an implanted medical device, consult your health care provider.

Hearing aids

Some digital wireless devices may interfere with some hearing aids. If interference occurs, consult your service provider.

Vehicles

RF signals may affect improperly installed or inadequately shielded electronic systems in motor vehicles such as electronic fuel injection systems, electronic antiskid (antilock) braking systems, electronic speed control systems, and air bag systems. For more information, check with the manufacturer, or its representative, of your vehicle or any equipment that has been added.

Only qualified personnel should service the device or install the device in a vehicle. Faulty installation or service may be dangerous and may invalidate any warranty that may apply to the device. Check regularly that all wireless device equipment in your vehicle is mounted

and operating properly. Do not store or carry flammable liquids, gases, or explosive materials in the same compartment as the device, its parts, or enhancements. For vehicles equipped with an air bag, remember that air bags inflate with great force.

Using your device while flying in aircraft is prohibited. Switch off your device before boarding an aircraft. The use of wireless teledevices in an aircraft may be dangerous to the operation of the aircraft, disrupt the wireless telephone network, and may be illegal.

Potentially explosive environments

Switch off your device when in any area with a potentially explosive atmosphere, and obey all signs and instructions. Potentially explosive atmospheres include areas where you would normally be advised to turn off your vehicle engine. Sparks in such areas could cause an explosion or fire resulting in bodily injury or even death. Switch off the device at refuelling points such as near gas pumps at service stations. Observe restrictions on the use of radio equipment in fuel depots, storage, and distribution areas; chemical plants; or where blasting operations are in progress.

Areas with a potentially explosive atmosphere are often, but not always, clearly marked. They include below deck on boats, chemical transfer or storage facilities and areas where the air contains chemicals or particles such as grain, dust, or metal powders. You should check with the manufacturers of vehicles using liquefied petroleum gas (such as propane or butane) to determine if this device can be safely used in their vicinity.

Compliance with EMF

Koninklijke Philips Electronics N.V. manufactures and sells many products targeted at consumers, which, like any electronic apparatus, in general have the ability to emit and receive electromagnetic signals. One of Philips' leading

Business Principles is to take all necessary health and safety measures for our products, to comply with all applicable legal requirements and to stay well within the EMF standards applicable at the time of producing the products. Philips is committed to develop, produce and market products that cause no adverse health effects. Philips confirms that if its products are handled properly for their intended use, they are safe to use according to scientific evidence available today. Philips plays an active role in the development of international EMF and safety standards, enabling Philips to anticipate further developments in standardisation for early integration in its products.

products will help prevent potential negative consequences for the environment and human health.

- Batteries (including built-in rechargeable batteries) contain substances that may pollute the environment. All batteries should be disposed of at an official collection point.

Cleaning and disinfection

- Unplug the device before cleaning.
- Use a soft cloth, if necessary dampened with a minimum amount of water or diluted mild soap, to clean the product.
- Products for disinfection of surfaces in clinical areas and patient care equipment, such as surface disinfectant wipes, can be used to clean the device.
- Do not use harsh chemicals or strong detergents.
- Do not rub or strike the surface with anything hard as this may scratch or damage the surface permanently.

Disposal of your old product

- Your product is designed and manufactured with high quality materials and components that can be recycled and re-used.
- When this crossed-out wheeled bin symbol is attached to a product, it indicates that the product is covered by the European Directive 2002/96/EC.
- Become informed about your local separate collection system for electrical and electronic products.
- Act according to your local rules and do not dispose of old products with normal household waste. The correct disposal of old



2 Your SpeechMike Air

Congratulations on your purchase and welcome to Philips!

To fully benefit from the service that Philips offers, visit our Website for support information such as user manuals, software downloads, warranty information and more:

www.philips.com/dictation.

2.1 What's in the box

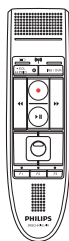

Dictation microphone



Docking station



Receiver module



Neckband



AC charger

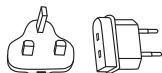

Exchangeable charging pins



Rechargeable batteries



Pouch

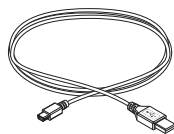

USB cable

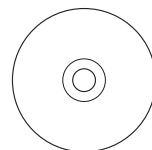

CD-ROM containing software and user manual

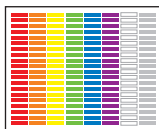

Color stickers



Quick start guide

2.2 Overview SpeechMike Air

2.2.1 Dictation microphone

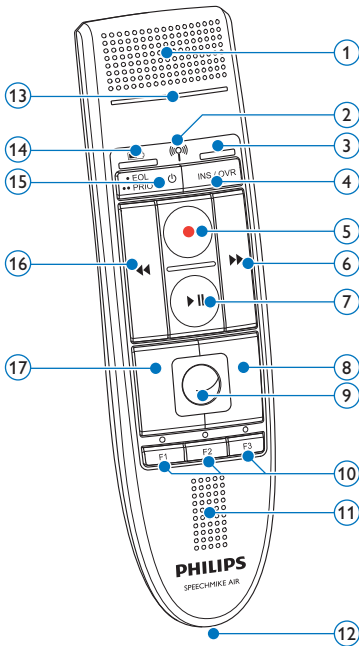

- ① Microphone
- ② Wireless connection indicator light
- ③ Battery charge level indicator light
- ④ On/Off key, EOL end-of-letter key, PRIORITY priority key
- ⑤ Record key
- ⑥ Fast forward key
- ⑦ Play/pause key
- ⑧ Right mouse button
- ⑨ Trackball
- ⑩ F1, F2, F3 Programmable function keys
- ⑪ Speaker
- ⑫ Docking station connector

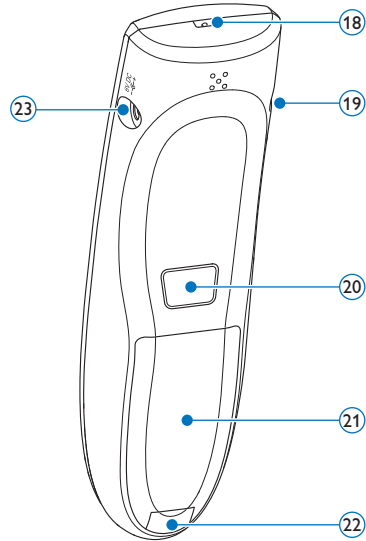

- ⑬ Record indicator light
- ⑭ Battery charge level indicator light
- ⑮ On/Off key, EOL end-of-letter key, PRIORITY priority key
- ⑯ Left mouse button
- ⑰ Strap hole
- ⑱ Headset connector
- ⑲ Left mouse button
- ⑳ Battery cover
- ㉑ Battery cover release button
- ㉒ Battery cover release button
- ㉓ Charger connector

2.2.2 Docking station

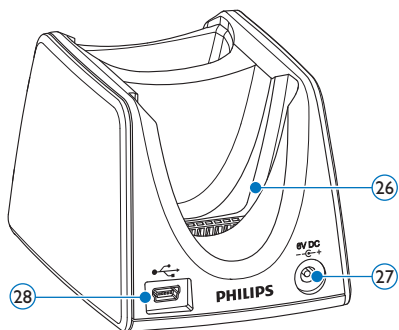
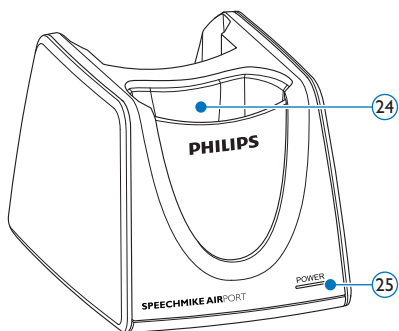

- 24 SpeechMike docking slot
- 25 Power indicator light

- 26 Receiver module docking slot
- 27 Charger connector
- 28 Mini USB connector

2.2.3 Receiver module

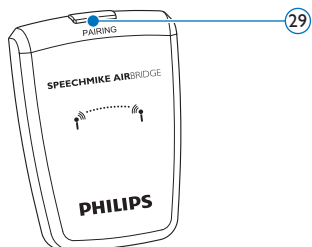

- 29 Pairing key



- 30 USB connector
- 31 Docking station connector

3 Get started

3.1 Install the software

Recording and playback of dictations with the SpeechMike requires dictation software such as *Philips SpeechExec* to be installed on the computer. When third-party dictation software other than *Philips SpeechExec* is used, driver software must be installed before connecting the SpeechMike.

! Important

Administrator rights are required to install the software. For more help, contact your administrator.

- 1 Turn on the computer.
- 2 Insert the installation CD in the CD-ROM drive. The set-up program should start automatically. If it does not, open the CD contents in Windows Explorer and double-click the *autorun.exe* file.
- 3 Click the **Install** button.
- 4 Follow the on-screen instructions of the set-up program.

3.2 Connect the docking station

- 1 The charger comes with four plugs, one for most European countries, one for the UK, one for the US and Canada and one for Australia. Before you use the charger for the first time select the correct plug fitting the wall outlets in your country and mount it onto the power adapter.

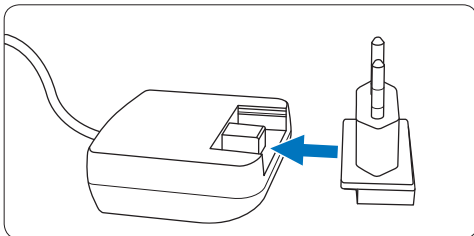

- 2 Plug the charger into a wall outlet and connect the charger cable to the charger connector of the docking station.

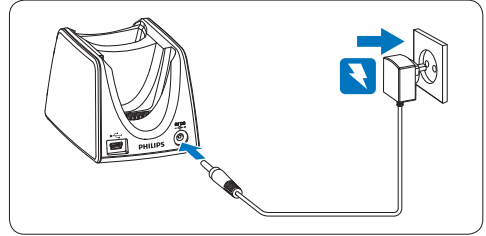

- 3 Connect the USB cable to the USB port of the computer and the mini USB connector of the docking station.

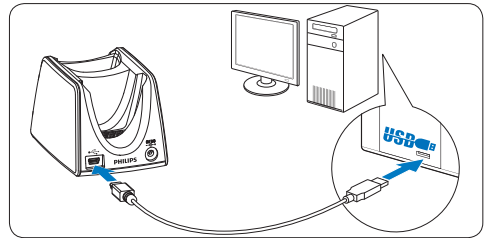

- 4 Insert the receiver module into the corresponding slot of the docking station and press it down firmly until it locks.

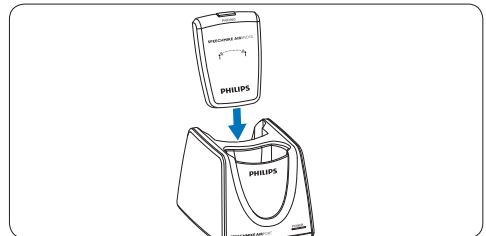

Tip

For the mobile user, the receiver module can be used without the docking station by directly connecting it to the computer using the USB cable.

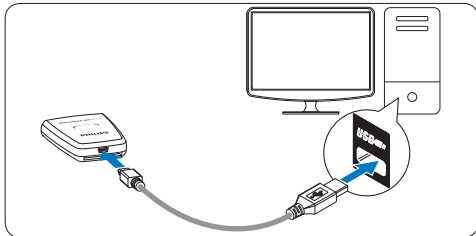

3.3 Insert the batteries

The SpeechMike can be operated with the rechargeable Philips batteries LFH9154 or AAA alkaline batteries.

- 1 Press down the battery cover release button and open the battery cover.

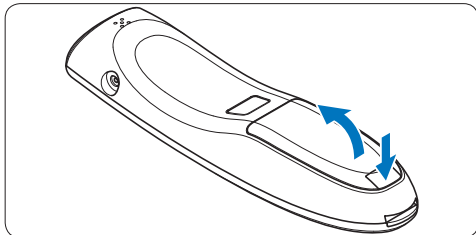

- 2 Place the batteries in the correct polarity as indicated and close the cover.

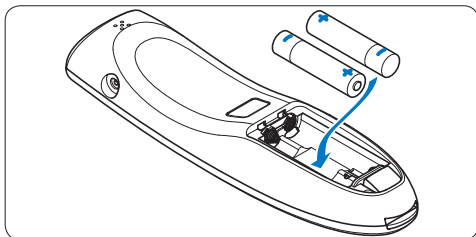

Notes

- Do not mix batteries of different types and/or brands.
- Remove the batteries if you will not be using the SpeechMike for an extended period of time. Leaking batteries may damage the SpeechMike.
- Stop recording before replacing the batteries. Removing the batteries during recording may result in data loss.

3.4 Charge the batteries

The rechargeable Philips batteries LFH9154 can be charged in the SpeechMike using the docking station in combination with the USB cable or the AC charger. It is also possible to charge the batteries by directly connecting the AC charger to the SpeechMike. A complete recharge cycle takes about 2.5 hours.

Warning

Use only the original charger. Using another charger may damage the device.

Notes

- Batteries other than the supplied Philips batteries LFH9154 cannot be charged.
- Fully charge the batteries before first use.

3.4.1 Charging using the docking station and the AC charger

The rechargeable Philips batteries LFH9154 can be charged in the SpeechMike using the docking station in combination with the AC charger.

- 1 Ensure that the AC charger is connected to the docking station (see chapter 3.2 for more information).
- 2 Insert the SpeechMike into the docking slot of the docking station and press it down firmly until it locks.
 - The battery level charge indicator flashes orange during charging.
 - The battery level charge indicator glows green when charging is complete.

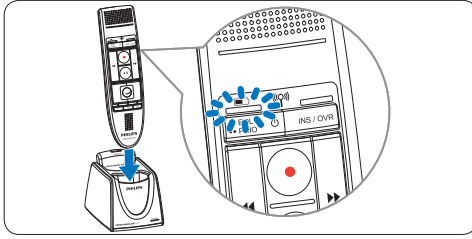

3.4.2 Charging using the docking station and the USB cable

The rechargeable Philips batteries LFH9154 can be charged in the SpeechMike using the docking station in combination with the USB cable.

- 1 Ensure that the docking station is connected to the computer using the USB cable (see chapter 3.2 for more information).
- 2 Insert the SpeechMike into the docking station and press it down firmly until it locks.
 - The battery level charge indicator flashes orange during charging.
 - The battery level charge indicator glows green when charging is complete.

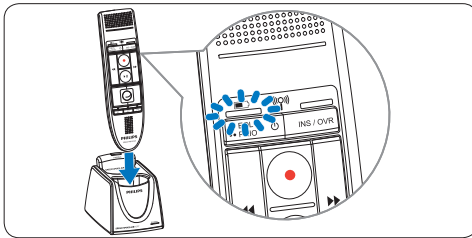

Notes

- The computer must be switched on when charging the batteries with the USB cable.
- If the USB port of the computer does not supply enough power supply capacity, use the AC charger.

3.4.3 Charging directly through the SpeechMike

The rechargeable Philips batteries LFH9154 can be charged in the SpeechMike by directly connecting the AC charger to the SpeechMike.

- 1 Plug the charger into a wall outlet and connect the charger cable to the charger connector of the SpeechMike.

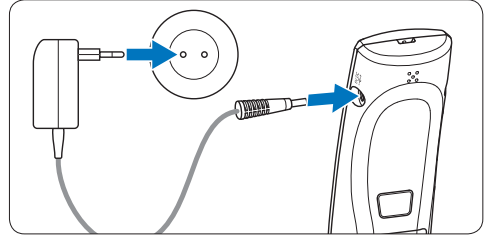

3.5 Learn about the battery charge level

Immediately after turning the SpeechMike on or when the SpeechMike is placed in the docking station, the battery charge level indicator light will indicate the battery status.

Battery charge level indicator	Battery status
Green	30% or more of charge remaining
Orange	Less than 30% of charge remaining
Red	Less than 10% of charge remaining

The battery charge level indicator will continuously flash red with about 30 seconds of recording time remaining.

3.6 Turning on/off the SpeechMike

- 1 To turn on the SpeechMike, press and hold **On/Off** for about 5 seconds. The battery indicator will light up.

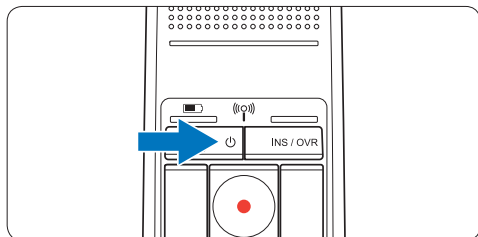

- 2 Once turned on the SpeechMike will reconnect automatically to the docking station.
 - The wireless connection indicator on the SpeechMike flashes blue while the connection is being established.
 - If the connection succeeds, the blue indicator lights permanently.
 - If the automatic wireless connection fails, set up the connection manually (see below).
- 3 To turn off the SpeechMike, press and hold **On/Off** for about 5 seconds. The SpeechMike beeps, and the battery indicator will light up red briefly.

3.7 Set up the wireless connection manually

The SpeechMike and the receiver module are paired by factory default and usually do not need to be connected manually. If the automatic wireless connection fails or if you want to pair the SpeechMike with another receiver module, set up the connection manually.

3.7.1 Set up the wireless connection manually using the docking station

- 1 Ensure that the receiver module is inserted in the docking station.
- 2 Switch on the SpeechMike, insert it into the

docking slot of the docking station and press it down firmly until it locks.

- 3 Press and hold the pairing key **[PAIRING]** on the receiver module for 3 seconds.
 - The receiver module enters pairing mode, and the pairing key starts to flash blue quickly.
 - If the connection succeeds, the wireless connection indicator on the SpeechMike and the pairing key on the receiver module glow blue permanently.

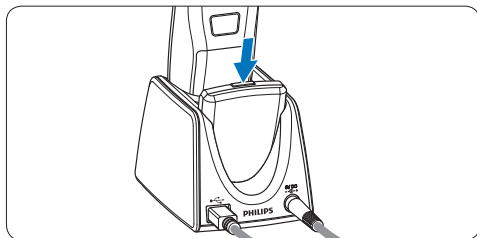

3.7.2 Set up the wireless connection manually using the receiver module

If the receiver module is used without the docking station, follow these steps to set up the wireless connection manually.

- 1 Ensure that the receiver module is connected to the computer with the USB cable and that the computer is switched on.
- 2 Press and hold the pairing key **[PAIRING]** on the receiver module for 3 seconds. The receiver module enters pairing mode, and the pairing key starts to flash blue quickly.

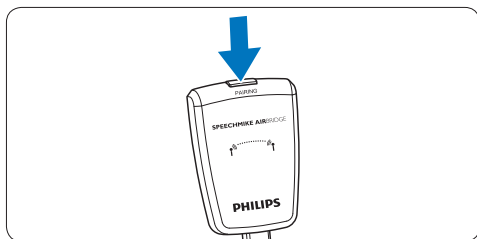

- 3 Switch on the SpeechMike and press the function keys **F1** and **F3** simultaneously for 1 second.

If the connection succeeds, the wireless connection indicator on the SpeechMike and the pairing key on the receiver module glow blue permanently.

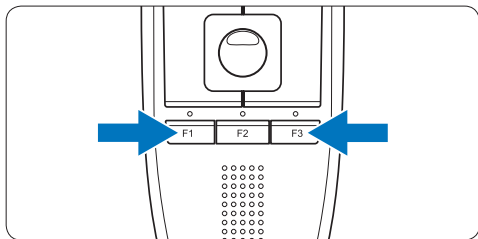

If you leave the reception area of the docking station a vibrating alert notifies you that the wireless connection between the docking station and the dictation microphone may become unstable. The dictation microphone beeps when the wireless connection is interrupted.

3.9 Power-save mode

If the SpeechMike is not used for more than two hours, it will automatically power down to save battery life. Turn the unit on by pressing  On/Off until the batterie indicator lights up.

3.8 Learn about wireless connectivity

The SpeechMike uses wireless technology to make a connection between the dictation microphone and the docking station.

A wireless connection does not require that the dictation microphone and the docking station be in line of sight, but the maximum distance between the devices is 10 meters (33 feet). The closer the devices are to each other, the better is the performance. The optimal operating range is shown in dark grey in the picture. The connection is subject to interference from distance and obstructions (shown in light grey) or other electronic devices.

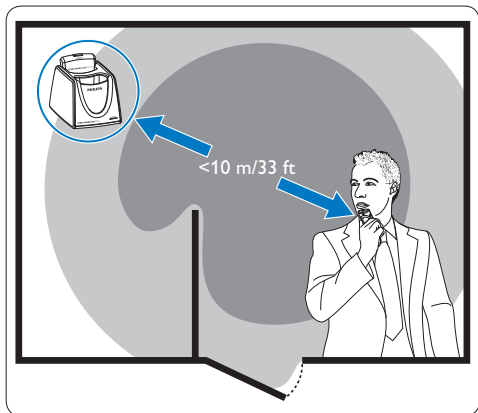

3.10 Locate the SpeechMike

- 1 Press the pairing key [PAIRING] on the receiver module briefly. *The SpeechMike connected to this receiver module beeps.*

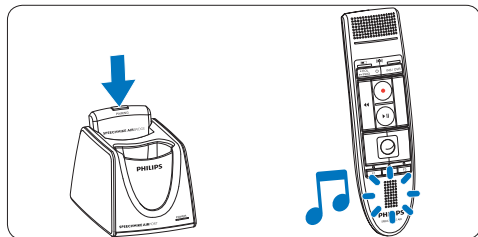

3.11 Attach the neckband



4 Use your SpeechMike Air

This chapter describes how to use the SpeechMike with *Philips SpeechExec* dictation software. If the SpeechMike is used with third-party software other than *Philips SpeechExec*, some features may not be present or function differently. For detailed information, refer to the documentation delivered with the software.

4.1 Create a recording

- 1 The docking station or the receiver module must be connected to the computer with the USB cable.
- 2 Press the **RECORD** key to create a new recording and enter *Record standby* mode.
 - *The recorder window is displayed.*
 - *The record indicator light flashes red (in overwrite mode) or green (in insert mode).*
- 3 Press the **▶||** key and start speaking. *The record indicator light glows in red (in overwrite mode) or green (in insert mode) while recording.*
- 4 For short pauses, press the **▶||** key. To continue recording, press the **▶||** key again.
- 5 To stop recording, press the **RECORD** key.
- 6 Press the **•EOL/••PRIO** key to mark the recording as finished.
 - *The dictation file is moved to the *Finished dictations* folder.*
 - *The recorder window closes and the work list window is displayed.*
- 7 To assign priority status to the recording, press the **•EOL/••PRIO** key again within half a second.

Note

- For best results, speak clearly and keep the microphone about 10 to 15 centimeters (4 to 6 inches) away from your mouth.
- The maximum distance between the docking station and the dictation microphone is 10 meters (33 feet). If you leave the reception

area of the docking station a vibrating alert notifies you that the wireless connection between the docking station and the dictation microphone may become unstable. Re-enter the reception area of the docking station. When the wireless connection is interrupted, the dictation microphone beeps and the dictation software stops recording. See [Learn about wireless connectivity](#) on page 14 for more information about wireless connectivity.

5 Use more of your SpeechMike Air

5.1 Customize the SpeechMike

Use the *Device Control Center* software to customize the SpeechMike to suit individual user needs.

The software allows to assign different functions to each key, enable or disable certain features and also to start and control applications with the SpeechMike.

5.1.1 Customize SpeechMike keys and settings

- 1 Ensure that the docking station is connected to the computer with the USB cable and that the wireless connection to the dictation microphone is established.
- 2 If the option to start the *Device Control Center* automatically was selected during installation, open the program by clicking the  icon in the notification area of the Windows task bar. To manually start the program, open the Windows start menu in Windows and select [All Programs > Philips Speech Control > Philips Device Control Center](#).

The current settings are automatically downloaded from the connected SpeechMike.

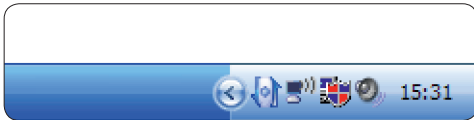

- 3 On the *Device* tab, configure device settings and select the function to be assigned to each key.

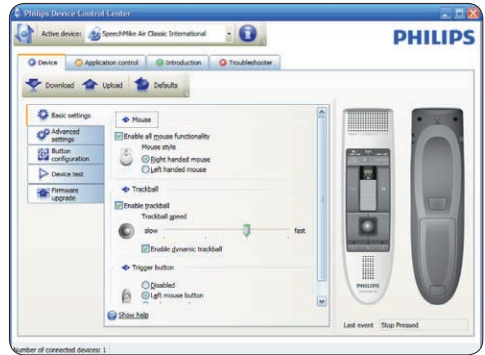

- 4 Click the **Upload** button to save the new settings.

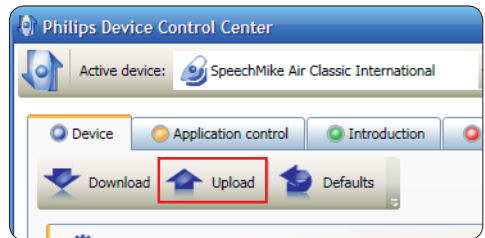

Note

- Settings cannot be changed when the battery charge level of the SpeechMike is below 10 % (when the battery charge level indicator is red). Charge the dictation microphone before changing the settings.
- The SpeechMike can be reset to its factory default configuration by clicking the **Defaults** button. Click the **Upload** button to save the default settings.



Tip

To test settings and key functions, use the *Device* test section on the *Device* tab.

5.1.2 Use application shortcuts

The *Device Control Center* software allows to start and control other applications with the keys on the SpeechMike.

The *Device Control Center* software includes pre-installed profiles that make the SpeechMike ready for immediate operation with Dragon NaturallySpeaking speech recognition software and Microsoft Powerpoint. Additional profiles for other applications can be programmed.

- 1 If the option to start the *Device Control Center* automatically was selected during installation, the application icon  appears in the notification area of the Windows task bar. To manually start the program, open the Windows start menu in Windows and select [All Programs > Philips Speech Control > Philips Device Control Center](#).
- 2 Right-click on the application icon  in the notification area of the Windows task bar and verify that 'Activate application control' is enabled. If the option is disabled, the configured settings and buttons will not function for any of the target applications.

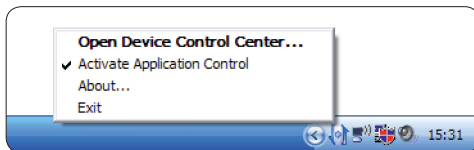

Note

Exit *Philips SpeechExec* software when using application shortcuts to prevent unintentional recording when controlling other applications.

Default profile

The default profile is applied automatically when there is no profile assigned to an application in focus. This profile is set up to control Dragon NaturallySpeaking with your SpeechMike. The following settings are defined:

SpeechMike key	Assigned shortcut
● Record	Record (push to dictate)
▶▶ Play/Stop	Play from cursor position
◀◀ Rewind	Move cursor backwards
▶▶ Fast forward	Move cursor forwards
•EOL/••PRIO	Mark backwards
INS/OVR	Open correction window

Powerpoint profile

Use this profile to control Powerpoint presentations with the SpeechMike. The following settings are defined:

SpeechMike key	Assigned shortcut
● Record	Black screen
▶▶ Play/Stop	White Screen
◀◀ Rewind	Go to previous slide
▶▶ Fast forward	Go to next slide
•EOL/••PRIO	End slide show
INS/OVR	Show/hide cursor

Note

Philips cannot guarantee the proper function of all assigned shortcuts, since shortcuts can differ among versions and languages.

Program a custom profile

It is possible to program shortcuts for other applications to control application functions with the keys of the SpeechMike.

- 1 Ensure that the docking station is connected to the computer with the USB cable and that the wireless connection to the dictation microphone is established.
- 2 If the option to start the *Device Control Center* automatically was selected during installation, open the program by clicking the  icon in the notification area of the Windows task bar. To manually start the program, open the Windows start menu in Windows and select [All Programs > Philips Speech Control > Philips Device Control Center](#).



3 On the tab **Application control**, click the **Add** button to create a new profile.

4 Browse and select the application executable and click on **OPEN**.

A profile for the selected application will be added to the list of profiles.

Note

Exit the target application during configuration. Open the application when the device configuration settings are saved.

5 Select a button from the button column and click the **...** icon to assign a shortcut. You can assign different shortcuts for pressing and releasing a key.

The shortcut editor window is displayed.

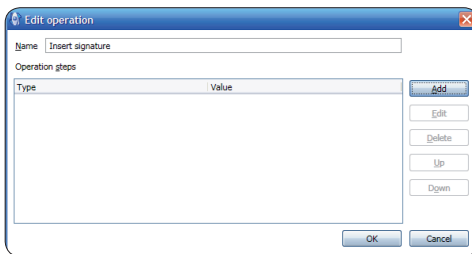

6 Enter name for the shortcut and click the **Add** button add an operation for the shortcut. The following options are available:

- Hotkey: Assign a keyboard shortcut
- Text: Enter the text to be inserted when a key on the SpeechMike is pressed
- Start an application by pressing a key on the SpeechMike
- Mouse button

- Dragon NaturallySpeaking command
- Delay

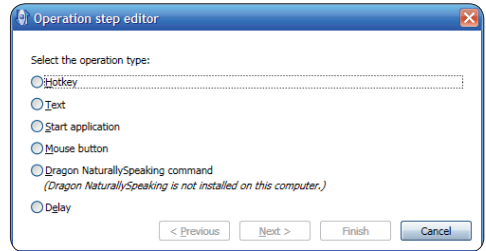

7 You can add one operation or a sequence of operations for every shortcut.

8 Click the **Apply** button to save the new settings.

Note

The *Device Control Center* cannot be used to program application shortcuts for *Philips SpeechExec* software. Shortcuts for *Philips SpeechExec* can be configured in the **General settings** menu of *SpeechExec*. See the *SpeechExec* application help for more information.

Tip

Application control configuration settings can be saved into files and imported later to apply the same configuration settings to several devices.

5.1.3 Update the firmware

Your SpeechMike is controlled by an internal program called firmware. Newer versions of the firmware may have been released after you have purchased the SpeechMike.

- 1 Download the firmware update for your SpeechMike model from www.philips.com/ dictation.
- 2 Ensure that the docking station is connected to a wall outlet with the AC charger and to the computer with the USB cable. The dictation microphone must be in the docking slot of the docking station.
- 3 If the option to start the *Device Control Center* automatically was selected during

installation, open the program by clicking the  icon in the notification area of the Windows task bar. To manually start the program, open the Windows start menu in Windows and select **All Programs > Philips Speech Control > Philips Device Control Center**.

- 4 On the **Device** tab, click on **Firmware update**.
- 5 Click the **Import** button and select the folder with the firmware files to be imported.
- 6 Click the **Upgrade** button to install the new firmware.
 - *The firmware upgrade takes about 30 seconds.*
 - *During firmware upgrade the indicator lights of the SpeechMike will be flashing.*
 - *When the firmware update is finished, the green battery indicator will light up.*

Warning

Do not remove the dictation microphone from the docking station during firmware upgrade. This might damage your product.

5.2 Record with a headset or an external microphone

Connect a compatible headset or external microphone to the SpeechMike. The internal microphone is switched off when an external microphone is connected.

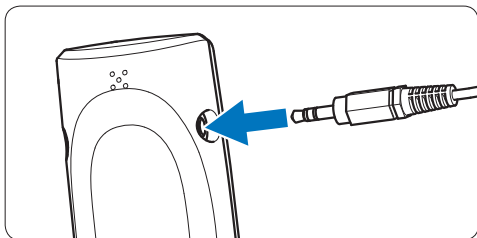

6 Technical data

Connectivity

- Wireless connection with operating range up to 10 meters (33 feet)
 - USB: Mini-USB 2.0
 - DC in: 6 V
 - Headset: 3.5 mm
-

Microphone

- Microphone type: electret condenser microphone
 - Microphone cartridge: 10 mm
 - Characteristic: uni-directional
 - Frequency response: 100 – 7500 Hz
 - Microphone sensitivity: -37 dB @ 1 kHz
 - Signal-to-noise ratio: > 70 dBA
-

Speaker

- Built-in 30 mm round, dynamic speaker
 - Acoustic frequency response: 300 – 7500 Hz
 - Output power: > 200 mW
-

Specifications

- Product dimensions (W x D x H):
45 x 165 x 30 mm / 1.8 x 6.5 x 1.2 inch
 - Weight: 125 g / 4.4 oz (including batteries)
-

System requirements

- Pentium III, 500 MHz and 512 MB RAM;
Recommended: Pentium IV or similar, 1 GHz and 1 GB RAM
 - 100 MB hard disk space for SpeechExec, 250 MB for Microsoft .NET Framework
 - One free USB port
 - Recommended minimum transfer rate for LAN: 100 Mbit/s
 - Windows Vista (with Service Pack 1),
Windows XP (with Service Pack 3)
-

Power

- Battery type: two Philips AAA Ni-MH rechargeable batteries (LFH9154) or two AAA batteries (LR03 or R03)
 - Power supply: 6 V DC / 850 mA
 - Up to 7 hours of recording (with Philips rechargeable batteries LFH9154)
 - Typical time for a full charge: 2.5 hours
-

Green specifications

- Compliant to 2002/95/EC (RoHS)
 - Lead-free soldered product
-

Operation conditions

- Temperature: 5° – 45° C / 41° – 113° F
 - Humidity: 10 % – 90 %
-

Optional accessories

- Philips noise-canceling headset LFH3090
 - Philips SpeechMike Air docking station LFH3050
 - Philips AAA Ni-MH rechargeable batteries LFH9154
 - Philips power supply LFH9146
-

7 Frequently asked questions

The operating system stops responding after restart

Using the Philips SpeechMike together with certain USB hubs may cause the operating system to stop responding when the computer is started.

Unplug the SpeechMike before starting the PC and reconnect it afterwards. We recommend replacing the USB hub or connecting your SpeechMike directly to the USB port of the computer.

The SpeechMike is completely without function

Some computer providers limit the output power of USB ports to 100mA. These ports may not provide enough power for the SpeechMike to function properly.

Use the AC charger.

Connect the SpeechMike via the self-powered hub.

The SpeechMike does not respond to input commands

The wireless connection to the docking station may be interrupted.

Check the wireless connection.

Start the pairing process as described in this user manual.

The dictation microphone does not switch on

The battery is very low.

Charge the dictation microphone.

The dictation microphone does not connect to the docking station

Pairings may have been reset or dictation microphone has been previously paired with another docking station.

Start the pairing process as described in this user manual.

The SpeechMike is connected to the computer but sound will play on the computer's speaker only

Windows XP can support only one playback device at a time and may require setting the playback device back to "SpeechMike Air" if another playback device was enabled after the SpeechMike was installed.

- Set via Start > Control Panel > Sound and Audio Devices > Audio (tab)
- Or, right-click the speaker icon if it's in the toolbar and select Adjust Audio Properties

Windows Vista can support more than one playback device at a time, but if you disable the device for playback it is also disabled for recording. You may need to right-click and select "Show disabled devices" to change the setting.

- Set via Start > Control Panel > Sound > Playback (tab)
- Or, right-click the speaker icon if it's in your toolbar and select playback devices

Federal Communications Commission Notice

This equipment has been tested and found to comply with the limits for a Class B digital device, pursuant to part 15 of the FCC Rules. These limits are designed to provide reasonable protection against harmful interference in a residential installation. This equipment generates, uses, and can radiate radio frequency energy and, if not installed and used in accordance with the instructions, may cause harmful interference to radio communications. However, there is no guarantee that interference will not occur in a particular installation. If this equipment does cause harmful interference to radio or television reception, which can be determined by turning the equipment off and on, the user is encouraged to try to correct the interference by one or more of the following measures:

- Reorient or relocate the receiving antenna.
- Increase the separation between the equipment and the receiver.
- Connect the equipment into an outlet on a circuit different from that to which the receiver is connected.
- Consult the dealer or an experienced radio or television technician for help.

Modifications

The FCC requires the user to be notified that any changes or modifications made to this device that are not expressly approved by Philips may void the user's authority to operate the equipment.

Cables

Connections to this device must be made with shielded cables with metallic RFI/EMI connector hoods to maintain compliance with FCC Rules and Regulations.

Canadian notice

This Class B digital apparatus meets all requirements of the Canadian Interference-Causing Equipment Regulations.

Avis Canadien

Cet appareil numérique de la classe B respecte toutes les exigences du Règlement sur le matériel brouilleur du Canada.

Declaration of Conformity

Model Number: LFH3000, LFH3010, LFH3020
Trade Name: Philips SpeechMike Air
Responsible Party: Philips Speech Processing
Address: 64 Perimeter Center East, Atlanta, GA 30346, USA
Telephone number: 888-260-6261
Website: www.philips.com/dictation

LFH3000, LFH3010, LFH3020



Tested to comply with
FCC standards

FOR HOME OR OFFICE USE

This device complies with Part 15 of the FCC Rules. Operation is subject to the following two conditions: 1) This device may not cause harmful interference. 2) This device must accept any interference received, including interference that may cause undesired operation.

CE Declaration of Conformity

Philips confirms that the product corresponds to the relevant guidelines of the European Union.



Discover the comprehensive range of professional dictation products from Philips
www.philips.com/dictation

Specifications are subject to change without notice.

Trademarks are the property of Royal Philips Electronics or their respective owners.

© 2009 Royal Philips Electronics. All rights reserved.

Document Version 1.0, 20/10/2009.