

# Philips 9750

## User Manual



**PHILIPS**

# Philips 9750 - User Manual

## VERSION

Philips 9750 - 05/2005 (English)

## COPYRIGHT

© 2003 - 2005 Philips Austria GmbH, PSP - Dictation Systems. All rights reserved. Reproduction in whole or in part is prohibited without the written consent of the copyright owner. Information in this manual is subject to change without notice.

## TRADEMARKS

Pocket Memo® is a registered trademark of Philips. Windows 2000 and Windows XP are registered trademarks of Microsoft Corporation. All other names are trademarks, registered trademarks or service marks of their respective owners.

## DISCLAIMER AND NOTICES

Philips has carried out extensive testing with most popular configurations. However, since PC add-ons and device drivers change very rapidly, we are unable to guarantee conflict-free operation.

The CE mark confirms that the device corresponds to the relevant guidelines of the European Union. The cardboard used for packaging can be recycled. This electronic facility contains recyclable material.



Technical changes and errors excepted.

Please note that not all accessories mentioned in this manual are necessarily part of the package contents. Descriptions of accessories, such as memory cards, additional microphones or the Foot Control, are for information only and do not require Philips to deliver any of these accessories with the *Philips 9750*.



## Declaration of Conformity

Tested to comply with FCC standards. For home or office use.

Model number:	Philips 9750
Trade name:	Philips Digital Pocket Memo
Responsible party:	Philips Speech Processing - Dictation Systems
Address:	64 Perimeter Center East, Fifth Floor, Atlanta, GA 30346, USA
Telephone number:	+1 770 821 2400

This device complies with Part 15 of the FCC Rules. Operation is subject to the following two conditions:

1. This device may not cause harmful interference.
2. This device must accept any interference received, including interference that may cause undesired operation.

**Table of Contents**

<b>Chapter 1: Introduction.....</b>	<b>1</b>
Features.....	1
Package contents .....	1
<b>Chapter 2: Introducing the Philips 9750.....</b>	<b>2</b>
Graphic .....	2
LCD display .....	3
<b>Chapter 3: First steps.....</b>	<b>4</b>
Activating the device .....	4
Memory card (optional).....	4
Formatting the memory card .....	4
Full memory card.....	4
Start screen .....	5
Display appearance .....	6
Power Save mode.....	6
Menu .....	6
Accessing the menu .....	7
General menu entries .....	7
Setting the date and time .....	7
Device beep .....	8
Backlight on/off.....	8
Changing the contrast .....	8
Displaying the recording time .....	8
Reformatting the memory card .....	9
Dictation-specific menu entries .....	9
User-defined labels .....	9
Assigning Keywords .....	10
Setting the recording format .....	10
Switching between Insert mode and Overwrite mode .....	10
Setting the microphone sensitivity .....	11
Voice-activated recording.....	11
<b>Chapter 4: Operating the Philips 9750 .....</b>	<b>12</b>
Transcription .....	12
Playback.....	12
Adjusting the volume, tone and speed .....	12
Fast Forward and Fast Rewind .....	12
Skip Forward and Skip Back .....	13
Auto-backspace.....	13
Deleting .....	13
Dictation .....	14
Recording a dictation.....	14
Finishing a dictation (EOL and Priority) .....	15
Removing EOL and Priority from a file .....	15
Insert mode and Overwrite mode .....	16
Recording format (Standard Play/Long Play mobile).....	16
Voice-activated recording.....	16
Conference recording .....	17
Transferring data.....	17
<b>Chapter 5: Advanced Operations .....</b>	<b>19</b>
Inserting index marks.....	19
Deleting index marks.....	19
Entering user-defined labels .....	20
Assigning Keywords.....	21
Example: Assigning Keywords .....	21
Linked Keywords.....	22
Example: Linked Keywords .....	22
Recording spoken instructions.....	23
Recording spoken instructions in Overwrite mode .....	24
Recording spoken instructions in Insert mode.....	24
Deleting spoken instructions .....	25
Working with the Foot Control LFH 0210/90B.....	25
Recording with the Foot Control LFH 210/90B .....	25
Foot Control and the Philips microphones LFH 276/10 and LFH 278/10 .....	25
Foot Control and Philips conference microphone LFH 172 .....	26

**Philips 9750 - User Manual**

**Appendix** ..... **27**  
    Troubleshooting the Philips 9750..... 27  
    Attaching the microphone bracket..... 28  
**Index** ..... **29**

## Chapter 1: Introduction

The Philips 9750 (digital Dictation/Transcription System) has been designed to offer optimum user convenience and greater efficiency for your daily work. This manual provides a comprehensive overview of all the device's features and detailed instructions on how to operate the device.

### Features

- State-of-the-art digital transcription system for the professional user.  
Digital transcription allows instant and precise access to any point in the dictation sound file.
- Compatible with all devices of the Philips Digital Pocket Memo range.
- The Philips 9750 provides workflow management capabilities for easy transfer of files to the PC.
- User-defined information (Keywords and labels) can be stored with the sound file.
- USB connection for simple data transfer between the device and the PC.
- Volume, tone and speed controls.
- Automatic backspace function.
- Ergonomic design.
- High-resolution LCD display with backlight.
- Support of Philips microphones LFH 276/10 and LFH 278/10 for use as a digital dictation system.
- Support of Philips conference microphone LFH 172.
- Support of Philips Foot Control LFH 0210.

### Package contents

- Philips 9750 - the digital Dictation/Transcription System for the professional user.
- Installation CD for *SpeechExec Dictate* for Windows 2000 and Windows XP.
- A USB cable.
- Power supply unit LFH 0155.
- Foot Control LFH 0210.
- Headphones LFH 0234.
- *Quick Reference* for Philips 9750

### Accessories available from your vendor

- Philips microphones LFH 276/10 and LFH 278/10
- Philips conference microphone LFH 172

For more information on Philips and the available products, go to:

[www.philips.com](http://www.philips.com)  
[www.philips.com/dictation](http://www.philips.com/dictation)





## Chapter 2: Introducing the Philips 9750

This chapter introduces the Philips 9750 through a series of graphics and explains the symbols on the LCD display.

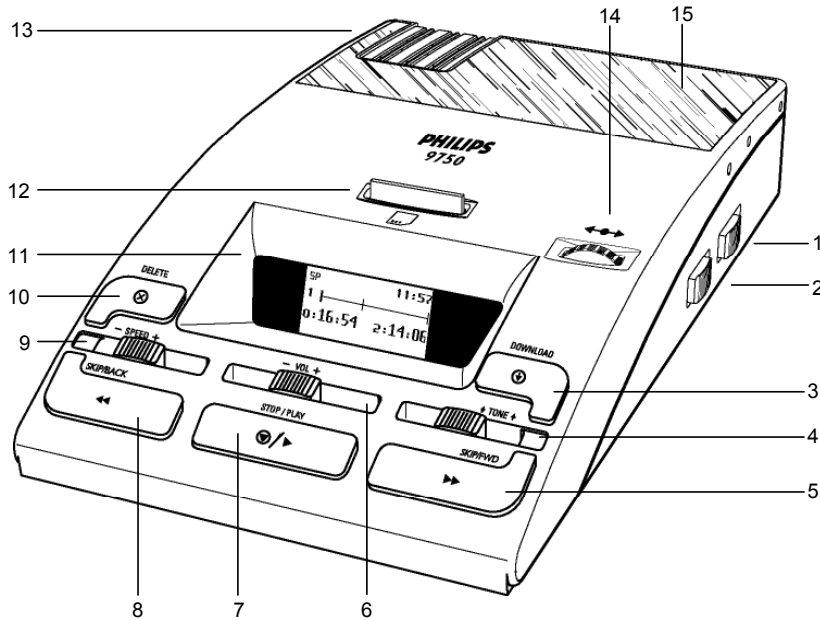
### Graphic

The following graphics show the device and the names of the various parts.



- 1: Auto-backspace switch ( ABS  ).
- 2: Speaker selector - for switching between playback through the external microphone (  ), the headphones (  ) or the built-in loudspeakers (  ).
- 3: DOWNLOAD: When the device is connected to the PC, this button activates the download function.
- 4: TONE: The control slider for adjusting the playback tone.
- 5: SKIP/FWD: The button for Fast Forward and Skip Forward.
- 6: VOL: The control slider for adjusting the playback volume.
- 7: STOP/PLAY: The button for starting/stopping playback.
- 8: SKIP/BACK: The button for Fast Rewind and Skip Back.
- 9: SPEED: The control slider for adjusting the playback speed.
- 10: DELETE: The button for delete operations.
- 11: LCD display.
- 12: Memory card slot.
- 13: Storage space for additional memory cards.
- 14: Jog Dial: Skip Forward and Skip Back, accessing the menu and moving between menu entries.
- 15: Built-in loudspeakers.

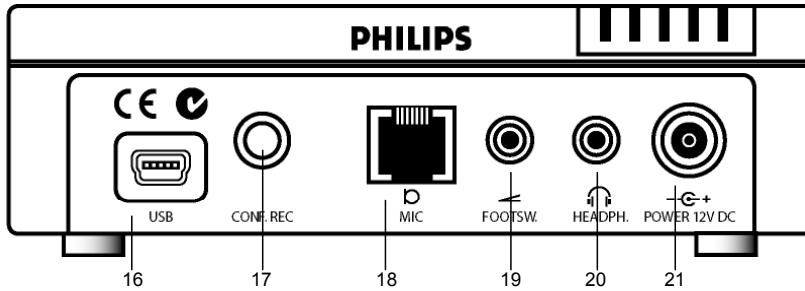

16: USB socket for PC download.

17: Socket for Philips conference microphone LFH 172.

18: Socket for Philips microphones LFH 276/10 and LFH 278/10.

19: Foot Control socket.

20: Headphones socket.

21: Power supply socket.

### LCD display

The Philips 9750 has a high-quality graphical LCD display. You will see the following symbols:

	Standard Play		Long Play mobile
	AM symbol (hours before noon)		PM symbol (hours after noon)
	Fast Rewind		Fast Forward
	Recording		Playback
	Stop		Voice-activated recording
	EOL (End-of-Letter)		Priority
	Write-protected file		Insert mode

### Status indication bar

The status indication bar may appear as follows (note that the following overview only lists the most common displays of the status indication bar):

	A dictation is being recorded.
	A sound file is being played back.
	A section of the sound file is marked for deletion.
	The whole sound file is marked for deletion.
	The sound file has index marks.
	The sound file includes spoken instructions.

### Chapter 3: First steps

This chapter provides an introduction to the basic functions of the Philips 9750:

- Activating the device
- Memory card
- Start screen
- Menu
- Power Save mode

#### Activating the device

The Philips 9750 is turned on and off by connecting/disconnecting the device to the mains power supply.

#### Memory card (optional)

The Philips 9750 operates with a memory card of the type MMC or SD. It supports MMC and SD cards with storage capacities of up to 1 GB. For example, a 32 MB memory card of the type MMC supports about 312 minutes of recording time in SP format or 468 minutes of recording time in LPM format.

If there is no memory card inserted into the device, this screen is displayed:



After inserting the memory card, one of the following screens will be displayed:

- If the memory card is new and has not been formatted, a confirmation dialog for formatting the memory card is displayed:

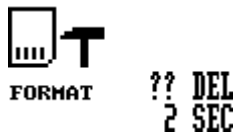

- If the memory card has been in use before, a start screen with the information stored on the memory card is displayed:

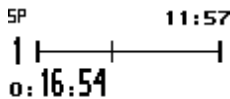

#### Formatting the memory card

When you insert a new, unformatted memory card, the following screen is displayed:

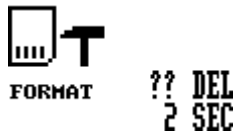

To confirm and start the formatting process, press the DELETE button for at least two seconds. If you want to cancel the formatting process, either remove the memory card or press the SKIP/BACK, STOP/PLAY or SKIP/FWD button.

**Important:** Any memory card used with devices of the DPM product range should be formatted by one of these devices and not any other device.

For more information on reformatting the memory card, refer to the corresponding *Menu* section of this manual.

#### Full memory card

If only two minutes of recording time are left on the memory card, the recording time on the display will start to blink. This can either be the remaining recording time or the used-up recording time. Note that this additional time display is only available in combination with the **Advanced** display option.



## Philips 9750 - User Manual

When the memory card is full, a warning is displayed and the device beeps; recording stops.

SP                    11:57  
1 |-----|  
2:30:00 0:00:00

### Start screen

After the memory card has been inserted or the Philips 9750 is turned on, a start screen is displayed. This screen is identical to the screen which is displayed when the device is in Stop mode.

The following screen is a fictional screen with the maximum number of symbols which could appear.

1 2 3 4 5 6  
| | | | | |  
SPLPm 0 7 VA PM 1:57  
7—34 |-----|—10  
8—7! 16:54 7 2:14:06—11  
9—0:16:54 7 2:14:06—11  
Jones  
12

- 1: The recording format. This can be either SP or LPm.
- 2: The SD memory card is write-protected.
- 3: Insert mode is activated. The default setting is Overwrite mode. For Overwrite mode, no symbol is displayed.
- 4: Voice-activated recording mode is enabled.
- 5: AM (or PM) symbol if the US time format is used.
- 6: The current time in HH:MM (hours:minutes).
- 7: The current file number. The current file will always be the last file you worked on. If you do not jump to a different file, this file will be opened automatically.
- 8: The dictation is marked as finished (EOL, End-of-Letter: #) and has a Priority (!) assignment.
- 9: The recording or playback time of the current dictation.
- 10: The status indication bar. This is a graphical display for the space left on the memory card. When recording, playback, winding etc. is done in the sound file, the bar displays the corresponding symbols and actions. The bar above also indicates that the sound file contains a spoken instruction.
- 11: The remaining recording time (-) or used-up recording time (+) on the memory card depending on the setting made with *SpeechExec Dictate*. The displayed time also depends on the SP/LPm setting.
- 12: The current Keyword 1 assignment.

## Display appearance

The appearance of the Philips 9750 display depends on the corresponding setting (**Standard display** and **Advanced display** options) in *SpeechExec Dictate*. For more information, refer to the *SpeechExec Dictate Online Help*.

- The **Standard display** option uses larger symbols without showing the status indication bar:

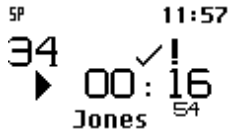

- The **Advanced display** option uses smaller symbols. It enables to view more information on the current dictation and shows the status indication bar. This bar provides visual feedback when a dictation, for example, is recorded or played back.

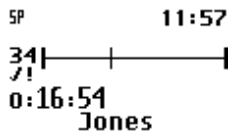

## Power Save mode

If the Philips 9750 is left inactive for more than 15 minutes, it goes automatically into Power Save mode and the display is turned off. You can reactivate the device by pressing any button.

When the device has been reactivated, it will reenter the mode which was active before it entered the Power Save mode.

**Note:** If you have voice-activated recording enabled and the device is in Record Standby mode, it will go into Power Save mode after 60 minutes.

## Menu

The Philips 9750 comes with a menu which provides the following menu entries:

- Date and time:
- Device beep:
- Backlight:
- Contrast:
- Remaining recording time (-02:59) or used-up recording time (+03:05)
- Format:
- User-defined labels:
- Keyword assignment:
- Recording format: **SP** L P m
- Insert mode and Overwrite mode:
- Microphone sensitivity:
- Voice-activated recording:

**Note:** The setting for the display appearance (**Standard display** and **Advanced display** options), for enabling/disabling the record notification beep and for recording into one file only can only be made via *SpeechExec Dictate*.

**Note:** If the one file function is activated, any recording will be stored in a single file. The Skip Forward, Skip Back and EOL functions are not available. If the record notification beep is enabled, you will hear two beeps every time the Philips 9750 goes into Recording mode.

## Philips 9750 - User Manual

### Accessing the menu

You can access the menu by pressing the Jog Dial (◀▶) for about two seconds. The menu can only be accessed when the device is in Stop mode.

- To move between the menu entries, move the Jog Dial left or right: 
- To select a menu entry, for example the date and time setting, go to this menu entry by moving the Jog Dial. Then press the Jog Dial to confirm the selection. This enables you to access the menu entry and change the settings for it. Confirm the changes by pressing the Jog Dial; this returns you to the main menu.

To exit a menu entry selection without confirming the changes, press the DELETE (Delete) button (⊗). This exits the main menu and discards any changes.

**Note:** If no menu entry selection is made within ten seconds, the device automatically exits the menu and goes back into Stop mode.

To exit the menu, do one of the following:

- Select the menu entry for exiting the menu and confirm the selection by pressing the Jog Dial: 
- Press the DELETE button.

### General menu entries

The following menu entries are for making general settings on the Philips 9750 which will be used for transcription and dictation.

- Setting the date and time
- Enabling and disabling the device beep
- Backlight on/off
- Changing the contrast
- Displaying the recording time
- Reformatting the memory card

### Setting the date and time

The Philips 9750 displays the date and time in the following format:

YYYY-MM-DD (year-month-day) and HH:MM (hours:minutes)

**Note:** If the preferred setting for the time is the American time format (configurable via *SpeechExec Dictate*), the 12-hour time format with AM/PM symbols is used.

The menu entry for the date and time displays the current date setting:

2005  
12-30  
OK ◀▶

Confirm the menu entry selection by pressing the Jog Dial and do the following:

1. Set the year by moving the Jog Dial up or down. Confirm the setting by pressing the Jog Dial.

2005-12-30  
↑ OK ◀▶

2006-12-30  
↑ OK ◀▶

11:57

11:57

2. Set the month and the day.

2006-12-30  
↑ OK ◀▶

2006-01-30  
↑ OK ◀▶

11:57

11:57

## Philips 9750 - User Manual

3. Set the time.

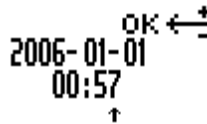
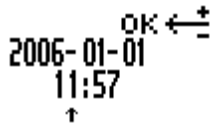

When you have set and confirmed the MM (minutes) setting, you will automatically return to the main menu.

**Note:** If you do not want to change, for example, the YYYY (year) setting, you can proceed to the MM (month) setting by pressing the Jog Dial.



### Device beep

You can define whether you want the Philips 9750 to beep when specific operations take place. Otherwise the device is muted except for warnings, for example, when the memory card is almost full.

This is the menu entry for the device beep; a check mark next to the symbol indicates that the beep function is enabled. The symbol always shows the current setting:



Confirm the menu entry selection by pressing the Jog Dial and do the following:

- Enable the device beep; this is the default setting: 
- Disable the device beep: 

Confirm the setting by pressing the Jog Dial and to return to the main menu.



### Backlight on/off

The Philips 9750 provides a backlit display for improved visibility.

This is the menu entry for the display backlight; a check mark next to the symbol indicates that the backlit display function is enabled. The symbol always shows the current setting:



Confirm the menu entry selection by pressing the Jog Dial and do the following:

- Enable the backlight; this is the default setting. When you press a button on the device, the device display will be backlit for about eight seconds: 
- Disable the backlight: 

Confirm the setting by pressing the Jog Dial and to return you to the main menu.



### Changing the contrast

You can change the contrast setting for the display.

This is the menu entry for the contrast setting:



Confirm the menu entry selection by pressing the Jog Dial.

The Philips 9750 provides seven contrast levels, from low contrast  to high contrast . The default setting is level 5: .

Confirm your preferred contrast setting by pressing the Jog Dial; this also returns you to the main menu.

### Displaying the recording time

The Philips 9750 enables you to have an additional time displayed for the recording time. Depending on the setting which has been made in *SpeechExec Dictate* you will either see the used-up recording time or the remaining recording time. This time display also depends on the setting for the recording format (SP/LPm).

**Note:** The recording time is only displayed if you have set the **Advanced display** option for the display appearance in *SpeechExec Dictate*.

## Philips 9750 - User Manual

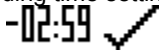
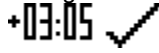
- This is the menu entry for the remaining recording time setting; the check mark next to the symbol indicates that this additional time is currently displayed: 
- This is the menu entry for the used-up recording time setting; the check mark next to the symbol indicates that this additional time is currently displayed: 

To disable the display of this additional time, confirm the menu entry selection by pressing the Jog Dial. Move the Jog Dial to have the symbol without the check mark and confirm your changes by pressing the Jog Dial again. You will return to the main menu.

### Reformatting the memory card

You can erase any data on the memory card by reformatting the memory card.

This is the menu entry for reformatting:



Confirm the menu entry selection by pressing the Jog Dial. The following screen is displayed:



FORMAT      ?? DEL  
                 2 SEC

To reconfirm and start the reformatting process, press the DELETE button for at least two seconds. This will erase all data on the memory card permanently.

**Note:** You can cancel the reformatting process by moving the Jog Dial or pressing the SKIP/BACK, STOP/PLAY or SKIP/FWD button.

**Note:** When reformatting a memory card of the type SD, make sure the card is not write-protected. A write-protected SD card is indicated with this symbol on the display: 

### Dictation-specific menu entries

The following menu entries are for making settings on the Philips 9750 which are specific for using the device as a digital dictation system.

- User-defined labels
- Assigning Keywords
- Setting the recording format
- Switching between Insert mode and Overwrite mode
- Setting the microphone sensitivity
- Voice-activated recording

#### User-defined labels

This menu entry is only available if the corresponding option has been enabled in *SpeechExec Dictate* and the setting was transferred to the Philips 9750. If enabled, it is displayed as the first entry when you access the menu.

LABEL-1  
9      OK ←→

The Philips 9750 stores the last user-defined label(s) you entered. These will be displayed when you access the menu entry. You can either accept the existing labels or enter new labels. For more information, refer to the *Entering user-defined labels* section in this manual. For more information on *SpeechExec Dictate*, refer to the Online Help delivered with the program.

### Assigning Keywords

This menu entry is only available if Keywords have been defined with *SpeechExec Dictate*. It is always displayed as the first menu entry unless you can also create user-defined labels on the device:

**AUTHOR:**  
Jones  
OK ←

This is an example screen for a Keyword menu entry which has been defined as follows: *usage = Author, content = a selection of author names*; the current Keyword assignment is the author name *Jones*. When you confirm the menu entry selection by pressing the Jog Dial, the list of all defined author names is displayed.

For more information on assigning Keywords, refer to the *Assigning Keywords* section in this manual. For more information on Keywords, refer to the *SpeechExec Dictate Online Help*.

If the Philips 9750 has been configured with the **Linked Keywords** setting, this menu contains the available Keyword sets. For more information, refer to the *Linked Keywords* section in this manual.

**Note:** If no Keywords are defined and no user-defined labels are enabled, the menu selection starts with the menu entry for setting the date and time on the Philips 9750.

### Setting the recording format

When used as a digital dictation system, the Philips 9750 enables to record dictations either in the Standard Play or the Long Play mobile recording format. The default setting is Standard Play (SP).

This is the menu entry for the recording format; the current setting is indicated with large, bold letters:

**SP** LP<sub>m</sub>

Confirm the menu entry selection by pressing the Jog Dial and do the following:

- Set LP<sub>m</sub>: LP<sub>m</sub>
- Set SP: SP

Confirm the setting by pressing the Jog Dial and to return to the main menu. For more information on the recording format, refer to the *Dictation* section in this manual.

### Switching between Insert mode and Overwrite mode



When used as a digital dictation system, the Philips 9750 supports these recording modes: Insert mode and Overwrite mode.

Insert mode means that newly dictated information is added to the dictation sound file at the current position in the sound file. Overwrite mode means that newly dictated information replaces already recorded sound at the current position.

This is the menu entry for switching between Insert mode and Overwrite mode; the symbol always shows the current setting:



Confirm the menu entry selection by pressing the Jog Dial and do the following:

- Set Insert mode:  ✓
- Set Overwrite mode: 

Confirm the setting by pressing the Jog Dial and to return to the main menu.

### **Setting the microphone sensitivity**

The setting for the microphone sensitivity defines the audio input level for the external microphones when using the Philips 9750 for as a digital dictation system.

This is the menu entry for the microphone sensitivity; the symbol always shows the current setting:



Confirm the menu entry selection by pressing the Jog Dial and do the following:

- Set the microphone sensitivity to low when recording dictations in a noisy environment :
  - Set the microphone sensitivity to medium when recording dictations in a normal environment; this is the default setting:
  - Set the microphone sensitivity to high when, for example, recording at a conference:
- Confirm the setting by pressing the Jog Dial and to return to the main menu.

### **Voice-activated recording**

When using the Philips 9750 for digital dictation, the device supports the voice-activated recording mode.

This is the menu entry for voice-activated recording; a check mark next to the symbol indicates that voice-activated recording is enabled. The symbol always shows the current setting:



Confirm the menu entry selection by pressing the Jog Dial and do the following:

- Enable voice-activated recording:
- Disable voice-activated recording; this is the default setting:

Confirm the setting by pressing the Jog Dial and to return to the main menu.

For more information on the voice-activated recording mode, refer to the *Voice-activated recording* section in this manual.

## **Chapter 4: Operating the Philips 9750**

The Philips 9750 provides enhanced functions for both transcription and dictation and can be operated in the following ways:

- The Philips 9750 is a fully operational, conventional digital transcription device for the playback and transcription of sound files recorded with the any devices of the DPM product range (version 2). You do not need a PC, but have the added benefit of digital recordings.
- The Philips 9750 can also be used as a digital dictation device in combination with Philips microphones, including conference microphones for making recordings at large gatherings.
- It can also be used as a component for the transcription of digitally recorded sound files in a workflow system. The sound files can be downloaded to a PC via the transcription device and be thus introduced into the transcription workflow.

For more detailed information on operating the Philips 9750 as described above, refer to the following sections:

- Transcription
- Dictation
- Recording
- Transferring data

### **Transcription**

This chapter provides an introduction to the basic functions of the Philips 9750 when used for transcription:

- Playback
- Adjusting the volume, tone and speed
- Fast Forward and Fast Rewind
- Skip Forward and Skip Back
- Auto-backspace
- Deleting

#### **Playback**

You can play back sound files through the built-in loudspeaker or the earphones. To start playback, press the STOP/PLAY button (⏮/▶).

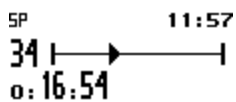

To stop playback, press the STOP/PLAY button again. When the end of the file is reached, playback stops automatically.

#### **Adjusting the volume, tone and speed**

The Philips 9750 enables you to adjust the volume (VOL slider: – VOL +), tone (TONE slider: ↓ TONE ↑) and speed (SPEED slider: – SPEED +) for the playback of sound files.

#### **Fast Forward and Fast Rewind**

The Philips 9750 supports fast forwarding and fast rewinding through a sound file.

- Keep the SKIP/FWD button (▶▶) pressed to fast forward a sound file; when the end of the sound file is reached, you will hear a beep and winding stops automatically.
- Keep the SKIP/BACK (◀◀) button pressed to fast rewind a sound file; when the beginning of the sound file is reached, you will hear a beep and winding stops automatically.



## Display during winding

- This is the display in Fast Forward mode:



- This is the display in Fast Rewind mode:

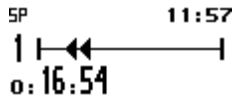

The winding speed starts at 5 times the playback speed. After two seconds it is accelerated to 10 times the playback speed; after eight seconds to 20 times and after thirty seconds to 100 times the playback speed.

## Skip Forward and Skip Back

The Philips 9750 also provides a skip function for moving between files. For skipping between files, you can either use the Jog Dial or the skip buttons (SKIP/BACK, SKIP/FWD).

- Press the SKIP/FWD button (▶▶) or move the Jog Dial (◀●▶) to the right to skip to the end of the current file. Then, pressing the SKIP/FWD button or moving the Jog Dial will always skip to the end of the next file.

For example, the current file number is 5. Pressing the SKIP/FWD button or moving the Jog Dial goes to the end of file number 5. Pressing the SKIP/FWD button or moving the Jog Dial again goes to the end of file number 6, then to the end of file number 7, and so on.

- Press the SKIP/BACK button (◀◀) or move the Jog Dial (◀●▶) to the left to skip to the beginning of the current file. Then, pressing the SKIP/BACK button or moving the Jog Dial will always skip to the beginning of the previous file.

For example, the current file number is 5. Pressing the SKIP/BACK button or moving the Jog Dial goes to the beginning of file number 5. Pressing the SKIP/BACK button or moving the Jog Dial again goes to the beginning of file number 4, then to the beginning of file number 3, and so on.

**Note:** When you skip forward and the last file is reached, a new empty file is created automatically.

Before you move the Jog Dial left or right, make sure that the device is in Stop mode.

## Auto-backspace

The Philips 9750 also provides an auto-backspace function (ABS slider: ABS ████). This is an automatic positioning feature for the playback of a dictation.

You can specify the auto-backspace value with the ABS slider on the device.

- To turn the auto-backspace function off, set the slider to 0.
- Any other setting means that playback does not restart at the point at which the dictation was stopped, but a few seconds earlier in the dictation.

## Deleting

The DELETE button (⊗) on the device can be used for two purposes: deleting a section from a sound file and deleting the whole sound file.

### Deleting a section

To delete a section from the current dictation, do the following:

- Go to the beginning of a section which is to be deleted by using SKIP/BACK, SKIP/FWD or STOP/PLAY. Make sure the device is in Stop mode and press the DELETE button once.

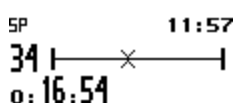

The beginning of the section is marked with x.

## Philips 9750 - User Manual

2. Use either SKIP/BACK, SKIP/FWD or STOP/PLAY to go to the end of the section that is to be deleted, bring the device into Stop mode and press the DELETE button again.

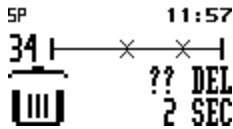

The end of the section is marked with another x. The open waste bin with a question mark indicates that the delete operation must be confirmed.

3. Confirm the operation by pressing the DELETE button again for at least two seconds and the section is deleted permanently from the file.



The waste bin symbol indicates that the section has been deleted.

**Note:** If a dictation sound file has been finished with the EOL indication, it is not possible to delete a section from that file.

### Deleting a file

To permanently delete an entire sound file, do the following:

1. If you do not have the file you want to delete already open, go to the file by moving the Jog Dial or pressing the skip buttons.
2. Make sure that the device is in Stop mode.
3. Press the DELETE button for at least two seconds.

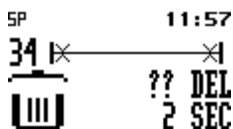

An x symbol appears at the beginning and the end of the file to indicate that the sound file is marked to be deleted.

4. Confirm the operation by pressing the DELETE button again for at least two seconds.

**Note:** To cancel any delete operation, move the Jog Dial or press the SKIP/BACK, STOP/PLAY or SKIP/FWD button.

## Dictation

This chapter provides an introduction to the basic functions of the Philips 9750 when used for dictation:

- Recording a dictation
- EOL (End-of-Letter) and Priority
- Insert mode and Overwrite mode
- Recording format (Standard Play/Long Play mobile)
- Voice-activated recording

### Recording a dictation

The Philips 9750 enables you to create high-quality digital recordings when using the device in combination with the Philips microphones LFH 276/10 or LFH 278/10. To record a dictation, do the following:

1. On the Philips microphone LFH 276/10 press the REC button; the device goes into Record Standby mode (blinking LED). To start recording, move the slider to the Play position (▲) and start dictating.

On the Philips microphone LFH 278/10 move the slider to the REC position and start dictating.

**Note:** The Philips microphones LFH 276/10 and LFH 278/10 provide two settings for the microphone sensitivity: DICT / CONF

- The DICT setting should be used for recording in a normal environment.
- The CONF setting should be used for recording at large gatherings.

## Philips 9750 - User Manual

To further optimize the audio input level for recording, you can also set the microphone sensitivity on the Philips 9750. For more information, refer to the *Menu* section in this manual.

2. Speak clearly and keep a distance of approximately 4 inches (ten centimeters) between your mouth and the microphone.

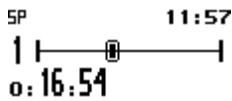

During recording, the Record LED is on.

3. On the Philips microphone LFH 276/10 move the slider to the Stop position (Ⓢ) to return to Record Standby mode. To stop recording, press the REC (Record) button again. To continue recording, move the slider back to the Play position (▶).

On the Philips microphone LFH 278/10 move the slider to the STOP position to stop recording. Move the slider back to the REC position to continue recording.

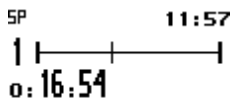

In Stop mode, the Record LED goes out.

4. When you are finished and do not want to make any further changes to the dictation, press the L/P button (P··) to mark the current dictation as finished (EOL indication, End-of-Letter: ¶). The file will be closed and a new, empty file is automatically generated. The file number is increased by one.

### Finishing a dictation (EOL and Priority)

The L/P button (P··) on the Philips microphones LFH 276/10 and LFH 278/10 has two functions: marking a dictation as finished (EOL function, End-of-Letter) and assigning priority to a dictation (Priority function). The L/P button is only operational if the Philips 9750 is in Stop mode and recording has been done in the file.

¶: The dictation is marked as finished (EOL, End-of-Letter).

!: The dictation has been assigned priority.

The functions of the L/P button are as follows:

- If you press the L/P button once, the current file is marked as finished (EOL indication). The file is closed and a new, empty file is created.

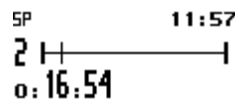
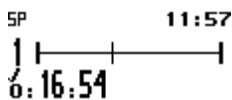

- If you press the L/P button twice within half a second, the current file is marked as finished (EOL indication) and assigned the Priority status. This also closes the current file and creates a new, empty file.

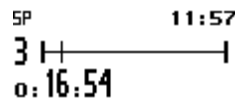
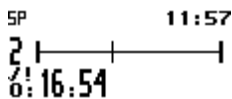

**Note:** If you have finished a file with the EOL indication, no further recording is possible in this file. It is also not possible to delete a section from the file.

### Removing EOL and Priority from a file

To remove the EOL indication or Priority assignment from a dictation, do the following:

1. Make sure the Philips 9750 is in Stop mode.
2. Go to the respective file by moving the Jog Dial or using the skip buttons.
3. To either remove the EOL indication or the Priority assignment, do one of the following:
  - To remove the EOL indication, press the L/P button once.
  - To remove the Priority status, press the L/P button twice within half a second.

### Insert mode and Overwrite mode

You can switch between Insert mode and Overwrite mode in the menu; for more detailed information, refer to the *Menu* section in this manual.

The default setting is Overwrite mode which means that new speech replaces existing speech in the sound file from the insertion point forward.

- This is the display in Stop mode and with Overwrite mode enabled:

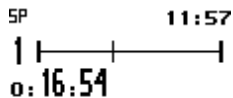

SP 11:57  
|-----|  
0:16:54

- This is the display in Stop mode and with Insert mode enabled:

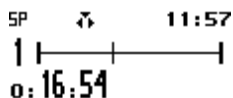

SP ↔ 11:57  
|-----|  
0:16:54

### Recording format (Standard Play/Long Play mobile)

The recording format determines the recording speed and audio quality of the recorded sound files.

SP : Standard Play recording format.

LP<sub>m</sub> : Long Play mobile recording format.

The default setting is SP. For more information on changing this setting, refer to the corresponding *Menu* section in this manual.

**Note:** Only one format can be selected for each file; the format for a file can be changed as long as no recording has been done in the file.

After recording has been done in the file, it is possible to switch between the SP and LP<sub>m</sub> recording format in the menu. This change will not take effect for the current file but from the next new file onwards. From that point on, any new files are recorded in the selected format until the setting is changed again.

The values for the two formats are as follows:

#### Standard Play (SP) 13.7 kbit/s

With this format, about 312 minutes of recording time are available on a 32 MB memory card. This recording format provides excellent audio quality. It is recommended when the dictation sound files are used, for example, for speech recognition.

#### Long Play mobile (LP<sub>m</sub>) 9.1 kbit/s

This recording format provides good audio quality. With this format, about 468 minutes of recording time are available on a 32 MB memory card.

### Voice-activated recording

Voice-activated recording mode is a convenient feature for hands-free dictation. When voice-activated recording is enabled, the Philips 9750 is in Record Standby mode; recording will start automatically when the input level exceeds a certain threshold (i.e. usually when you start dictating). This means that recording stops a few seconds after you stop speaking and restarts automatically when you start speaking again.

To operate the Philips 9750 in voice-activated recording mode, do the following:

1. Enable voice-activated recording in the menu.  
For more information, refer to the *Menu* section in this manual.
2. Make sure you have a Philips microphone LFH 276/10 or LFH 278/10 connected.
3. Set Record Standby mode:
  - On the Philips microphone LFH 276/10, press the Record button and move the slider to the Play position.
  - On the Philips microphone LFH 278/10, move the slider to the Record position.

4. Start dictating and recording will start automatically. The symbol for voice-activated recording is shown on the display.

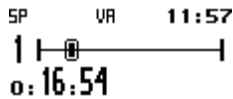

When you stop dictating, the Philips 9750 goes back into Record Standby mode after two seconds.

### Conference recording

When used in combination with the Philips conference microphone LFH 172, the Philips 9750 can also be used for making digital recordings, for example at conferences.

To set up the Philips 9750 for recording, do the following:

1. Make sure the Philips 9750 is connected to the mains power supply and that a memory card is inserted into the slot.
2. Connect the Philips conference microphone LFH 172 to the CONF.REC socket at the back of the device.
3. Turn on the microphone by pushing the ON switch down.
4. On the Philips 9750, press the DOWNLOAD (⏴) and SKIP/FWD (⏵) buttons simultaneously. This sets Record Standby mode.
5. To start recording, press the STOP/PLAY button (⏸/▶); pressing the button again returns you to Record Standby mode.
6. To switch from Record Standby mode to Stop mode when you have finished recording, press the SKIP/BACK or SKIP/FWD button.

### Transferring data

You can use the Philips 9750 as part of the workflow management for exchanging and transferring data with the PC. With *SpeechExec Dictate* you make settings and choose options on how to operate the device. This data can then be downloaded and is stored on the device.

You can also use the Philips 9750 for transferring data to the PC, for example, dictation sound files stored on the memory card. Depending on how you have configured the download process with *SpeechExec Dictate*, the download process is either started automatically or by pressing the DOWNLOAD button on the Philips 9750. You can also configure whether individual sound files or all of the sound files will be transferred from the device to the PC.

To transfer data from the Philips 9750 to the PC with the automatic download functionality enabled in the DPM Download/Configuration program, do the following:

1. Make sure the Philips 9750 is connected to the mains power supply and to the PC via the USB cable; and that the device is in Stop mode.
2. Press the DOWNLOAD button (⏴) on the Philips 9750 to establish the connection between the device and the PC.

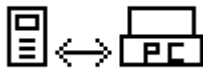

3. Press the DOWNLOAD button again to start the data transfer unless you have configured the automatic download process with *SpeechExec Dictate*; in this case, the download process starts automatically.
4. The progress of the file transfer is displayed.



5. When the download is finished, one of the following symbols will appear:

- The download finished successfully: 

## ***Philips 9750 - User Manual***

- The download did not succeed: 

**Note:** Whether the downloaded files on the Philips 9750 are deleted after transferring depends on the corresponding settings in *SpeechExec Dictate*.

To leave the USB mode, press the STOP/PLAY button.

### **Additional information**

- During transfer and as long as the Philips 9750 is connected to the PC, all buttons and switches on the device are inactive.
- For more information on the different download configuration options, including the automatic download procedure, refer to the *SpeechExec Dictate Online Help* or the *User Manual* delivered with the CD.

## Chapter 5: Advanced Operations

This chapter introduces you to some of the more advanced aspects of the Philips 9750:

- Inserting index marks
- Entering user-defined labels
- Assigning Keywords
- Linked Keywords
- Recording special instructions

**Note:** The function for assigning Keywords is only available when using the Philips 9750 together with *SpeechExec Dictate*. The recording of special instructions is only possible when using the Philips 9750 as a digital dictation device in combination with the Philips microphones LFH 276/10 or LFH 278/10.

- Working with the Foot Control LFH 0210

### Inserting index marks

When using the Philips 9750 as a digital dictation device in combination with the Philips microphones LFH 276/10 or LFH 278/10, the Philips 9750 supports inserting of index marks into your dictations.

Index marks can be inserted at any position in the sound file. You can insert an index mark during Playback or Recording mode. Proceed as follows:

1. Press the S button on the microphone for about 0.3 seconds. An index mark will be inserted at the current position in the sound file. The index mark appears a vertical bar on the display; additionally, the string *Index 1* is shown.

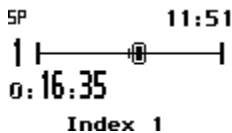

SP 11:51  
0:16:35  
Index 1

2. Continue recording.
3. Press the S button again to insert another index mark. Another vertical bar appears on the display and the string *Index 2* is shown.

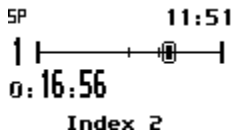

SP 11:51  
0:16:56  
Index 2

#### Additional information

- When you fast forward or fast rewind the file, the device will interrupt the current action at the insertion point of an index mark for about 1 second and it will beep. The action is then continued automatically.

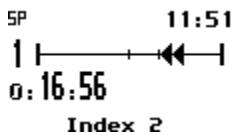

SP 11:51  
0:16:56  
Index 2

- In Playback mode, only the index mark string is shown on the display when the playback cursor moves over an index mark. The DPM will not beep and playback will not be interrupted.
- When you are recording in Overwrite mode, index marks will be overwritten without any warning.
- You can insert up to 32 index marks into one file.
- You cannot insert index marks into dictations which have been finished with EOL.

### Deleting index marks

To delete an index mark, do the following:

1. Go to the position of the index mark in the file using the fast forward or fast rewind function. Fast forward or fast rewind will stop automatically at the insertion point of an index mark and the DPM will beep.

**Note:** Do not use the playback function because playback does not allow you to position correctly at the insertion point of an index mark.

2. Press the DELETE button for about 2 seconds. The string for the index mark will flash. The index mark will be deleted after 2 seconds.

### **Entering user-defined labels**

A user-defined label is an alphanumeric string which can have up to 13 characters. Such a label is entered directly on the Philips 9750. If and how many user-defined labels can be entered depends on the corresponding setting in *SpeechExec Dictate*. For more information, refer to the Online Help delivered with the program.

When entering user-defined labels on the device you can use the characters A-Z and the numbers 0-9; spaces are also allowed.

To enter a user-defined label, do the following:

1. Press the Jog Dial for about two seconds to access the menu.

The menu entry for user-defined labels is displayed first per default. If you already entered a user-defined label previously, the menu entry will display this label.

```
LABEL-1
9      OK ←→
```

2. To start editing the label, press the Jog Dial again.

```
      OK ←→
9
↑
LABEL- 1
```

**Note:** If the mandatory user input option for entering user-defined labels has been set in *SpeechExec Dictate*, you will immediately access the menu at this level.

3. Select or change the first character/number of the label by moving the Jog Dial left or right. Confirm a character/number selection by pressing the Jog Dial.

```
      OK ←→
89
↑
LABEL- 1
```

4. When you have entered the complete label string, confirm by pressing the Jog Dial for about two seconds.



## Philips 9750 - User Manual

### Additional information

- If there is more than one user-defined label enabled, you will automatically go to the next label after confirming the first label:

```

LABEL-2
9
OK ←+

OK ←+

9
LABEL-2
  
```

- To delete a character from a label string, press the DELETE button briefly. To discard any changes you have made and to exit the menu, press the DELETE button for about two seconds.
- To insert a character into a label string, press the STOP/PLAY button.
- To move one character to the left, press the SKIP/BACK button; to move one character to the right either press the Jog Dial as described above or press the SKIP/FWD button.
- To re-use an already existing label without changing it, confirm the label by pressing the Jog Dial for about two seconds. The Philips 9750 will beep and you are required to confirm again.

### Assigning Keywords

The Philips 9750 enables you to personalize your dictations via predefined Keywords. For this purpose, you create a configuration file on the PC using the Download/Configuration program. For the Philips 9750 this configuration file can have up to five Keywords defined to be used on the device.

**Note:** Assigning Keywords as described below is only available if the Philips 9750 has not been configured with the **Linked Keywords** setting in *SpeechExec Dictate*.

Keywords are a combination of their usage definition and the content definitions for that usage. All this information is stored in the configuration file which is transferred to the Philips 9750. On the device, the authors can select from the predefined entries and assign them to their dictations. These entries are saved together with the dictation and can finally be used by the transcriptionist for filtering the dictations.

For more information on Keywords, refer to the *SpeechExec Dictate Online Help*.

#### Example: Assigning Keywords

The following Keywords have been defined with *SpeechExec Dictate*:

	<u>Keyword 1</u>	<u>Keyword 2</u>	<u>Keyword 3</u>	<u>Keyword 4</u>	<u>Keyword 5</u>
<u>Usage</u>	<i>Author</i>	<i>Patient</i>	<i>Document</i>	<i>Typist</i>	<i>Delivery</i>
<u>Content</u>	<i>Jones</i>	<i>Peter</i>	<i>Letter</i>	<i>Smith</i>	<i>Fax</i>
	<i>Singh</i>	<i>Steve</i>	<i>Memo</i>	<i>Simpson</i>	<i>Print</i>
	<i>Watson</i>	<i>Patricia</i>	<i>Report</i>	<i>Green</i>	<i>Email</i>

This information is transferred to the Philips 9750 where the author makes the required Keyword assignments.

Do the following:

- Press the Jog Dial for about two seconds to access the menu and display the Keyword's usage definition:

*Author*

```

AUTHOR:
Jones
  
```

```

OK ←+
  
```

**Note:** If a Keyword assignment has already been made, the current assignment is displayed as the menu entry, for example: *AUTHOR: Jones*

- Confirm the Keyword selection by pressing the Jog Dial. The Keyword's content definitions are displayed:  
*Jones, Singh, Watson*
- Move the Jog Dial to scroll to the name you want to assign.

```

OK ←+
  
```

```

Singh
  
```

## Philips 9750 - User Manual

- Confirm your selection by pressing the Jog Dial and to return to the main menu.
- Assign a second Keyword by moving the Jog Dial to display its usage definition: *Patient*

**PATIENT:**

OK ←<sup>+</sup>

- Confirm the Keyword selection by pressing the Jog Dial. The Keyword's content definitions are displayed: *Peter, Steve, Patricia*
- Move the Jog Dial to scroll to the subject you want to assign.

OK ←<sup>+</sup>

**Peter**

- Confirm your selection by pressing the Jog Dial and to return to the main menu.
- Assign a third Keyword by repeating the steps from above: *Document*

**DOCUMENT:**

OK ←<sup>+</sup>

OK ←<sup>+</sup>

**Report**

- Assign a fourth Keyword: *Typist*

**TYPIST:**

OK ←<sup>+</sup>

OK ←<sup>+</sup>

**Green**

- Assign a fifth Keyword: *Delivery*

**DELIVERY:**

OK ←<sup>+</sup>

OK ←<sup>+</sup>

**Fox**

The selected Keyword definitions will be stored with your dictation. Any new dictation you create will be assigned the same information unless you select different Keyword definitions.

You can select different Keyword definitions as long as no recording has been done in the file. After recording has been done in the file, it is possible to choose different Keyword definitions on the display. These changes will not take effect for the current file but from the next new file onwards.

**Note:** If the Philips 9750 goes into Power Save mode while assigning Keywords, the device is reactivated in Stop mode. Any unconfirmed Keyword assignments will have been discarded. You have to access the menu and repeat the Keyword assignment.

### Linked Keywords

When the **Linked Keywords** setting is enabled in *SpeechExec Dictate* and the Philips 9750 has been configured with this setting, you can transfer sets of Keyword strings to the Philips 9750. These sets can then be selected on the device and assigned to a dictation file.

A Keyword set is the sum of all content definitions which have been made in *SpeechExec Dictate* in the same row (see below). The name of the Keyword set is taken from the usage definition of Keyword 1; this name is also displayed on the Philips 9750 when you enter the menu. The usage definitions of any other Keywords are ignored.

#### Example: Linked Keywords

The usage definition of Keyword 1 is *patient*; the content definitions of the Keyword 1 column are patient names. Keyword 2 is the department, Keyword 3 the patient ID, Keyword 4 a comment, Keyword 5 the patient's gender. In this example, a Keyword set thus combines all of this patient data.

The **Keyword Definition** tab in *SpeechExec Dictate* is as follows:

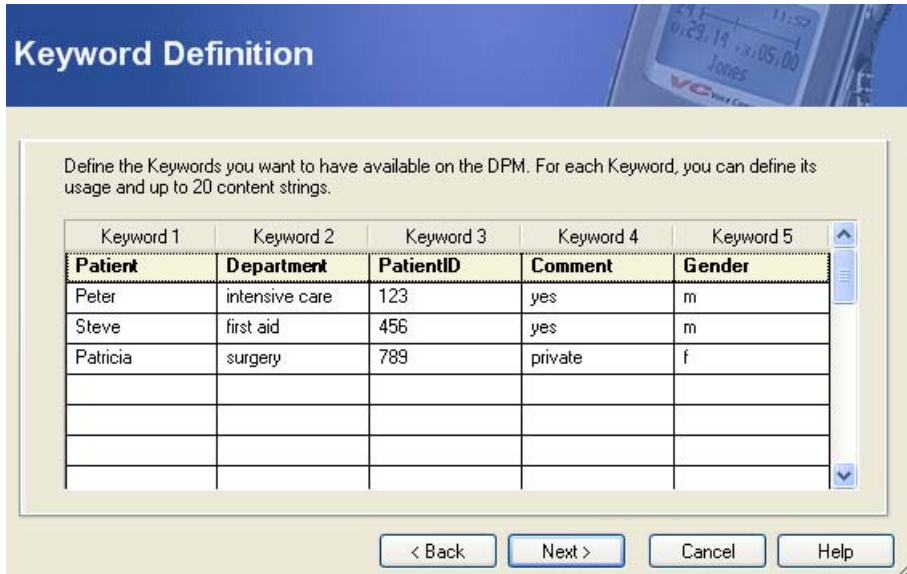

This defines the following Keyword sets:

Keyword set 1 = *Peter, intensive care, 123, yes, m*

Keyword set 2 = *Steve, first aid, 456, yes, m*

Keyword set 3 = *Patricia, surgery, 789, private, f*

After this configuration has been transferred to the Philips 9750, the Keyword sets can be selected on the device as follows:

1. Press the Jog Dial for about two seconds to access the menu. The Keyword set name (taken from the usage definition of Keyword 1) is displayed. If a Keyword set has already been assigned previously, two of the content definitions of the currently assigned set are also displayed, for example:

```
PATIENT:
Peter
Intensive care
OK ←
```

2. Press the Jog Dial again to access the available Keyword sets. The currently assigned set is displayed:

```
OK ←
Peter
Intensive care
123
yes
m
```

3. Move the Jog Dial to scroll to the Keyword set you want to assign.

```
OK ←
Steve
First aid
456
yes
m
```

4. Confirm the new assignment by pressing the Jog Dial and to return to the main menu. The menu entry displays the new Keyword set:

```
PATIENT:
Steve
First aid
OK ←
```

This Keyword set is now assigned automatically to any new dictation file.

## **Recording spoken instructions**

Spoken instructions can be compared to comments which are recorded by the author during dictation. They are stored within the dictation sound file at the position in the sound file where the instruction was actually recorded. Examples for spoken instructions are 'insert a paragraph here' or 'correct spelling is Z E L A Z O W S K I'.

## Philips 9750 - User Manual

When using the Philips 9750 as a digital dictation device in combination with the Philips microphones LFH 276/10 or LFH 278/10, the Philips 9750 supports the recording of spoken instructions for dictations. Spoken instructions can only be inserted in Recording mode.

To insert an instruction, do the following:

1. Make sure that the Philips 9750 is in Recording mode. For more detailed information, refer to the *Dictation* section in this manual.
2. Press the S button (·s) on the microphone for at least 1 second to insert your spoken instruction.
3. Keep the button pressed as long as you record your spoken instruction. When you are finished, release the button and continue with your normal dictation.

A spoken instruction appears as a thick horizontal bar on the status bar of the device display. The pictures below show the display while a spoken instruction is being recorded and after you have returned to normal recording.

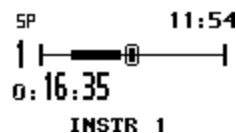
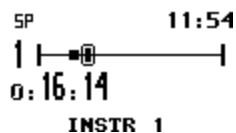

4. To insert another spoken instruction, follow the steps from above.

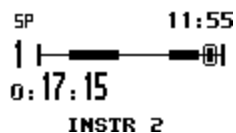

### Recording spoken instructions in Overwrite mode

When Overwrite mode is enabled on your device, the behavior is as follows:

- Spoken instructions will be overwritten, partially or completely, without any warning.
- When you start normal recording inside a spoken instruction and finish recording before you have reached the end of the spoken instruction, the instruction is split into two parts.

For example, you have a spoken instruction with a length of 12 seconds. You position inside the instruction at 5 seconds and do normal recording for 5 seconds. Your sound file will then have a spoken instruction of 5 seconds followed by normal recording of 5 seconds followed by the remainder of the instruction of 2 seconds.

However, the total length of the instruction has been decreased to 7 seconds because the middle part has been overwritten with the normal recording.

### Recording spoken instructions in Insert mode

When Overwrite mode is enabled on your device, the behavior is as follows:

- When you insert a spoken instruction before an existing one, the numbering of the consecutive instructions is increased by 1. For example, if you inserted an instruction before *INSTR 2*, *INSTR 2* would become *INSTR 3*, *INSTR 3* would become *INSTR 4* and so on.
- When you insert normal recording into an existing spoken instruction, the spoken instruction is split into two individual instructions. The total number of instructions in your sound file is increased by 1. However, the contents of the instruction are preserved and not overwritten.

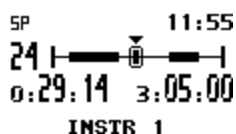

### Additional information

- When you fast forward or fast rewind the file, the device will interrupt the current action at the insertion point of a spoken instruction for about 1 second and it will beep. The action is then continued automatically.

## Philips 9750 - User Manual

While the device stops at a spoken instruction, the corresponding string is displayed on the device:

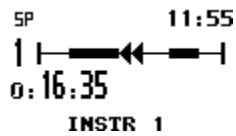

- In Playback mode, only the spoken instruction string is shown on the display when the playback cursor moves over a spoken instruction. The device will not beep and playback will not be interrupted.
- You can insert up to 32 spoken instructions into one file.
- You cannot insert spoken instructions into dictations which have been finished with EOL.
- You cannot insert an index mark into a spoken instruction.

### Deleting spoken instructions

Deleting a spoken instruction is similar to deleting a section from the sound file. Do the following:

1. Go to the beginning of the spoken instruction and press the DELETE button once.

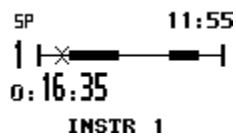

2. Go to the end of the spoken instruction and press the DELETE button again.

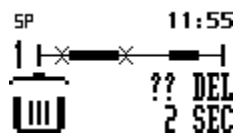

3. Confirm the delete operation by pressing the DELETE button for at least two seconds.

### Working with the Foot Control LFH 0210/90B

The Philips 9750 has been designed to work with a footpedal device for the control of playback functions.

#### Foot Control switches

The Foot Control has three switches: middle, left and right switch. Their functions are:

- When you press the middle pedal, **Fast Forward** is started; when you release it, **Fast Forward** is stopped.
- When you press the left pedal, **Fast Rewind** is started; when you release it, **Fast Rewind** is stopped.
- When you press the right pedal, **Playback** is started; when you release it, **Playback** is stopped.

There is a priority sequence among the three Foot Control pedals.

- The middle pedal has the highest priority. It stops actions started by the left or right pedal.
- The left pedal has the next highest priority. It stops actions started by the right pedal.
- The right pedal has the lowest priority.

### Recording with the Foot Control LFH 210/90B

The Foot Control is mainly used for transcribing dictations. However, it can also be operated in a mode which enables you to start and stop the recording functions. When you operate the Foot Control for recording, you can either use it in combination the Philips microphones LFH 276/10 and LFH 278/10 or the Philips conference microphone LFH 172.

#### Foot Control and the Philips microphones LFH 276/10 and LFH 278/10

To use the Foot Control in combination with the Philips microphone LFH 276/10 for recording, do the following:

1. Connect the Foot Control to the FOOTSW socket of the Philips 9750.
2. Set the switch on the underside of the Foot Control to the T position (press-and-release). This setting means that playback is started when the Playback pedal is pressed once. To stop playback, you have to press the pedal again.

## Philips 9750 - User Manual

**Note:** When you set the switch to the N position the function is press-and-hold. This setting means that you have to keep the Playback pedal pressed during playback. When you release the pedal, playback is stopped.

3. Connect the Philips microphone LFH 276/10 to the MIC socket of the Philips 9750.
4. Keep the REC button on the Philips microphone LFH 276/10 pressed and press the middle pedal on the Foot Control at the same time.
5. HF will appear on the display of the Philips 9750. This means that the device is now in Recording mode.

### To start and stop recording:

To start recording, press the right pedal. The recording LED on the Philips microphone LFH 276/10 shines red. To stop recording, press the right pedal again. The recording LED starts to blink. This indicates the dictation is in Record Standby mode.



### To finish recording and fast rewind:

To finish recording, press the left pedal. To fast rewind, keep the left pedal pressed. Release the pedal when you have reached the required position in the sound file.



### To start and stop playback:

When you have finished recording, you can start playback by pressing the right pedal. To stop playback, press the right pedal again.



### To switch from playback to recording:

Press the middle pedal; this sets Record Standby mode. The recording LED on the Philips microphone LFH 276/10 starts to blink. To start recording, press the right pedal. The recording LED shines red.



### To leave Recording mode:

Press the STOP/PLAY button on the Philips 9750.



## Foot Control and Philips conference microphone LFH 172



To use the Foot Control in combination with the Philips conference microphone LFH 172 for recording, do the following:

1. Connect the Foot Control to the FOOTSW socket of the Philips 9750.
2. Set the switch on the underside of the Foot Control to the T position (press-and-release). This setting means that playback is started when the Playback pedal is pressed once. To stop playback, you have to press the pedal again.

**Note:** When you set the switch to the N position the function is press-and-hold. This setting means that you have to keep the Playback pedal pressed during playback. When you release the pedal, playback is stopped.

3. Connect the Philips conference microphone LFH 172 to the CONF. REC socket of the Philips 9750.
4. Press the DOWNLOAD and the SKIP/FWD buttons on the Philips 9750 and the middle pedal of the Foot Control simultaneously.
5. HF will appear on the display of the Philips 9750. This means that the device is now in Recording mode. Operate the Philips 9750 in Recording mode as explained above.

### Appendix

The appendix provides this additional information:

- Troubleshooting the Philips 9750
- Attaching the microphone bracket

#### Troubleshooting the Philips 9750

##### Nothing appears on the display

- The Philips 9750 is turned off: Connect the Philips 9750 to the mains power supply.

##### Warning:

- The memory card cannot be read. Try a different memory card or a different type of memory card.
- The memory card is not formatted: Format the memory card via the menu.
- One of the buttons could be stuck: Make sure none of the buttons is stuck.

##### Philips 9750 is inactive

- The Philips 9750 is turned off: Connect the Philips 9750 to the mains power supply.

##### Recording is not possible

- There is not enough space left on the memory card: Delete files from the memory card or use a new memory card.
- The memory card is not formatted: Format the memory card.

##### No sound during playback

- The volume is turned down (0): Turn the volume up.
- Earphones are plugged into the Philips 9750: Unplug the earphones to listen to playback via the built-in loudspeaker.

##### Deleting files is not possible

- The file has been finished with EOL: Remove the EOL attribute from the file by pressing the L/P or EOL/P (End-of-Letter and Priority) button once.
- Your memory card, of the type SD, is write-protected (): Remove write protection from the SD card.

##### Wrong file

- The wrong file is being played back: Open the correct file.

##### Connection to the PC is not possible

###### USB driver has not been installed properly

Solution: Check whether the USB drivers have been installed correctly. If you did not complete the installation of the USB driver or canceled the 'Unknown device detected' process the first time you connected the Philips 9750 to your PC. Proceed as follows:

1. Connect the Philips 9750 to your PC.
2. Go to the **Start** menu, **Settings**, **Control Panel**, **System**, **Device Manager**.
3. Look for an unknown USB device in the list.
4. Select the **Unknown Device** and click **Remove**.
5. Click **OK** and close the **Control Panel** window.
6. Disconnect the Philips 9750 and reconnect it again.
7. The **Add New Hardware Wizard** is started. Click **Next**.
8. Follow the instructions which appear on the screen. When the wizard detects the driver (USB Mass Storage Device), click **Next** to copy the driver to your PC.
9. On the last wizard page, click **Finish** to complete the installation.

## Philips 9750 - User Manual

### Windows XP

When installing the Philips 9750, the operating system automatically assigns a drive for the Philips 9750. This drive appears as a 'removable disk' in the Windows Explorer. Sometimes, the drive letter assignment for the Philips 9750 conflicts with an existing drive letter mapping; this is why the Philips 9750 cannot be seen in the Windows Explorer. Additionally, *SpeechExec Dictate* displays the Philips 9750 status as **DPM (disconnected)**.

Solution: Mount all network drives starting with drive letters Z, Y, X (in reverse alphabetical order).

### PC sound system is not functioning

- The Philips 9750 is used as a USB sound device: Open the **Sounds and Multimedia Properties** dialog box in the Control Panel. Make sure your PC's sound system is the **Preferred device** selection. Activate the **Use only preferred devices** option.

### Attaching the microphone bracket

You can attach a microphone bracket for the Philips microphones LFH 276/10 or LFH 278/10 on the left or right side of the Philips 9750. Proceed as follows:

1. Align the microphone bracket with the mounting plate and attach it to the Philips 9750 with the long screw provided:

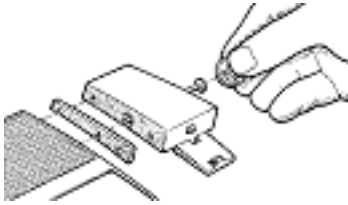

2. Connect the microphone to the MIC socket at the back of the Philips 9750.



Ⓚ  
MIC

3. Route the microphone cable through the cable trench underneath the microphone bracket:

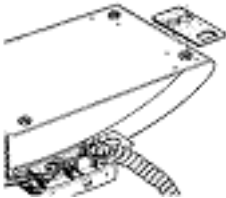



## **Index**

### **A**

Activate, 4  
Advanced display, 6  
Advanced operations, 19  
Appearance, 6  
Assign  
    Keywords, 10  
Authors, 21  
Auto-backspace, 13  
Automatic backspace, 13  
Automatic recording, 11, 16

### **B**

Backlight, 8  
Basic functions, 4  
Basics, 12  
    Dictation, 14  
    Transcription, 12  
Beep, 8  
Button  
    DELETE, 13  
    EOL, 15  
    L/P, 15  
    Priority, 15  
    SKIP/BACK, 12, 13  
    SKIP/FWD, 12, 13  
    STOP/PLAY, 12

### **C**

Card, 4  
Conference recording, 17  
Configuration file, 21  
Contrast, 8

### **D**

Data transfer, 17  
Date, 7  
Delete  
    File, 14  
    Section, 13  
    Spoken instruction, 25  
DELETE button, 13  
Delete operations, 13  
Dictation, 14  
    Record, 14  
Dictation-specific  
    Menu entry, 9  
Display, 3, 6, 8  
DPM display, 8  
DPM menu, 8

### **E**

End-of-Letter button, 15  
Entering user-defined labels, 20  
EOL, 15  
EOL button, 15

### **F**

Fast Forward, 12  
Fast Rewind, 12  
Features, 1  
File

Delete, 14  
    Skip Back, 13  
    Skip Forward, 13  
First steps, 4, 12  
Foot Control, 25  
Format  
    Memory card, 4  
Format for recording  
    Long Play mobile, 16  
    Standard Play, 16  
Functions, 4

### **G**

General  
    Menu entry, 7  
Graphic, 2

### **I**

Index marks, 19  
Insert, 24  
    Memory card, 4  
Insert mode, 10, 16  
Inserting index marks, 19  
Instruction  
    Delete, 25  
Instructions  
    Record, 24  
Introduction, 1, 2

### **J**

Jog Dial, 6  
    Keywords, 21  
    Skip Back, 13  
    Skip Forward, 13

### **K**

Keywords, 21  
    Linked, 22  
    Menu, 10

### **L**

L/P, 15  
L/P button, 15  
Label, 20  
LCD display, 3  
Linked Keywords, 22  
Long Play mobile, 10, 16

### **M**

Memory card, 4  
    Format, 4  
    Insert, 4  
    Reformat, 9  
Menu, 6, 7, 9, 10  
    Backlight, 8  
    Contrast, 8  
    Date and time, 7  
    Device beep, 8  
    Insert mode, 10  
    Keywords, 10  
    Microphone sensitivity, 11  
    Overwrite mode, 10

## Philips 9750 - User Manual

- Recording time, 8
- Reformatting the memory card, 9
- SP/LPm, 10
- User-defined label, 9
- Voice-activated recording, 11

- Menu entry
  - Dictation-specific, 9
  - General, 7

- Microphone, 14
- Microphone bracket, 28
- Microphone sensitivity, 11
- MMC, 4

- Mode
  - Insert, 10, 16
  - Overwrite, 10, 16
  - Power Save, 6

### O

- Operations
  - Advanced, 19
  - Basic, 12
- Overwrite, 24
- Overwrite mode, 10, 16

### P

- Package contents, 1
- Play, 12
- Playback, 12
  - Volume, 12
- Playback position, 13
- Power Save mode, 6
- Priority, 15
- Priority button, 15
- Program
  - SpeechExec Dictate, 17, 21

### R

- Record
  - Dictation, 14
  - Instructions, 24
- Recording, 17
- Recording format
  - Long Play mobile, 10, 16
  - Standard Play, 10, 16
- Recording mode
  - Insert, 10
  - Overwrite, 10
- Recording time, 8
- Reformat
  - Memory card, 9

### S

- SD, 4

- Section (sound file)
  - Delete, 13
- Settings
  - Volume, 12
- Skip Back, 13
- Skip Forward, 13
- SKIP/BACK, 12, 13
- SKIP/FWD, 12, 13
- Software
  - SpeechExec Dictate, 17, 21

- Sound file
  - Delete file, 14
  - Delete section, 13
  - Dictation, 14
  - Playback, 12
  - Transcription, 12
- Sound file format
  - Long Play mobile, 10, 16
  - Standard Play, 10, 16
- SP/LPm, 10, 16
- SpeechExec Dictate, 17
- Spoken instruction
  - Delete, 25
  - Insert mode, 24
  - Overwrite mode, 24
- Spoken instructions, 24
- Standard display, 6
- Standard Play, 10, 16
- Start screen, 5
- STOP/PLAY button, 12
- Symbols, 3

### T

- Time, 7
- Transcription, 12
- Transfer
  - Data, 17
- Turn on/off, 4

### U

- User-defined label, 20
  - Menu, 9

### V

- VA, 11, 16
- Voice-activated recording, 11, 16
- Volume, 12

### W

- Winding, 12
- Workflow management, 17